



Molto di più su [www.edilkamin.com](http://www.edilkamin.com)

**STUFE, TERMOSTUFE  
CALDAIE**



**EDILKAMIN**  
TECNOLOGIA DEL FUOCO

## Le certificazioni

Edilkamin è **CERTIFICATA UNI EN ISO 9001** sistema di qualità aziendale europeo nella versione globale (progettazione, produzione, commercializzazione).

Tutti i **PRODOTTI** Edilkamin, secondo necessità, oltre alla marcatura **CE**, vengono certificati in base alle norme:

- **EN 13229** - (focolari chiusi)
- **EN 13240** - (stufe a legna)
- **EN 14785** - (stufe a pellet)
- **EN 303-5** - (caldaie a legna e a pellet)

- **IMQ** - Istituto italiano marchio di qualità
- **VKF** - Certificazione Svizzera
- **FLAMME VERTE** - Marchio di Certificazione francese
- **BImSchV** - Requisiti tedeschi per apparecchi per il riscaldamento domestico
- **15 a BV-G** - Legge austriaca sulle emissioni
- **SINTEF** - Certificazione prodotto Norvegese
- **PCT** - Certificazione Russa
- **ISCIR** - Certificazione Rumena
- **BAFA** - Ministero dell' energia tedesco



**1** LAINATE - Milano (Italia)

**2** GABBIONETA - Cremona (Italia)

**3** NUVOLERA - Brescia (Italia)

**4** CONTROGUERRA - Teramo (Italia)

**5** GERONA (Spagna)

**6** SARVAR (Ungheria)

**7** COLONIA (Germania)

**8** DISON (Belgio)

**9** ATENE (Grecia)



Sede centrale Lainate (Italia)

Stabilimento di Gabbioneta (Italia)



Stabilimento di Sarvar (Ungheria)



Stabilimento di Controguerra (Italia)



Stabilimento di Gerona (Spagna)



Marmeria di Brescia (Italia)



## L'ALTA QUALITÀ DEL NOSTRO FUOCO.

Fondata nel 1963, Edilkamin costituisce oggi uno dei più grandi gruppi europei nella produzione di caminetti, stufe e caldaie e può vantare una tecnologia all'avanguardia in ogni fase di lavorazione.

Dal taglio lamiera effettuato con 7 modernissimi impianti laser, alla saldatura eseguita su altrettante postazioni robotizzate fino alla verniciatura realizzata con sofisticati robot, ogni operazione è controllata nei minimi dettagli e con un alto grado di specializzazione.

## RISCALDARE BENE, RISCALDARE TUTTI.

Agli elevati standard qualitativi, si affianca una politica di abbattimento dei costi: una produzione su scala industriale, dislocata in tutto il territorio europeo con 5 stabilimenti produttivi e oltre 400 dipendenti, consente a Edilkamin di proporre prodotti economicamente competitivi.

Perché se il nostro obiettivo è quello di fornire stufe e caminetti efficienti, solidi e tecnologici, vogliamo anche che il nostro fuoco possa essere a portata di ogni tasca.

# LA GAMMA PIÙ COMPLETA D'EUROPA

**TERMOPRODOTTI ad acqua.**  
Per riscaldare con l'acqua tutta la casa



## A PELLETT

Producono acqua calda per alimentare termosifoni, pannelli radianti a pavimento e acqua calda sanitaria per i bagni e la cucina (anche a impianti già esistenti), riscaldando ampie metrature. Possono affiancare altri generatori di calore come i pannelli solari o le caldaie murali.



IDROFLEXA C  
kW 11,3

ECOIDRO  
kW 11,3

MELODY LINE  
kW 14

TOP LINE  
kW 18

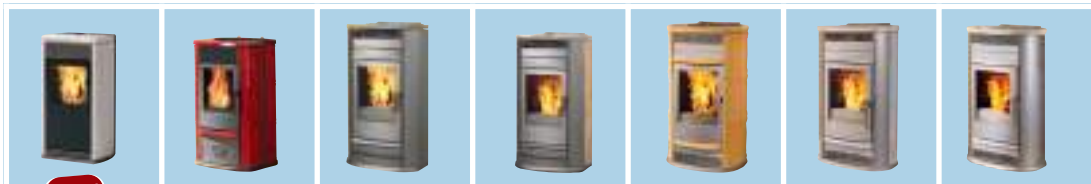

NEW

EXTRA LINE  
kW 24-33

TOP-LINE, EXTRA LINE  
kW 18-24-33

EK  
kW 29-45



NEW

NEW



## A LEGNA

Termostufe e caldaie per alimentare l'impianto termosifoni anche già esistente e produrre acqua calda sanitaria usando la legna, combustibile ecologico ed economico.

KLIMA / KLIMA CS  
kW 19,7 / 14

WARM / WARM CS  
kW 19,7 / 14

ENERGY  
kW 21/26/30/34

POWER  
kW 24/33



## STUFE ad aria. Per riscaldare con l'aria uno o più locali



### A PELLETT

Stufe automatiche e programmabili, semplici nella manutenzione e comode da caricare. Funzionano in continuo anche per più giorni, riducendo i costi del riscaldamento.



FORMA  
kW 6



NEW

KELLY  
kW 9

TWIN  
kW 6



NEW

TINY  
kW 9

SEVEN  
kW 7



FLEXA  
kW 8



NEW

MELODY LINE  
kW 10

IRIS UP  
kW 8



IRIS PLUS  
kW 8

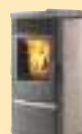

SIMPATY LINE  
kW 11

ROSE  
kW 8



TOP LINE  
kW 13,2

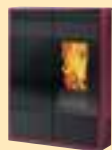

NEW



NEW



NEW



NEW

### A LEGNA

Classiche "stufe della nonna", rivisitate con la più moderna tecnologia per aggiungere all'atmosfera del fuoco della legna sicurezza, praticità, risparmio e rispetto per l'ambiente.

STYLO LINE  
kW 6

DELUXE  
kW 7

DIAMOND  
kW 7

IRIS LEGNA,  
OLYMPIA  
kW 7,8

CHIC, ELITE,  
VANITY  
kW 9,6



NEW



NEW



# INDICE ANALITICO

Aida .....	42	Funny .....	37	Power .....	28
Atlanta.....	23	Idroflexa C .....	20	Prestige.....	14
Basic.....	22	Iris legna .....	62	Quebec .....	10
Boston.....	11	Iris Plus .....	52	Rio.....	32
Cherie .....	38	Iris Up .....	50	Roller .....	66
Chic .....	60	Kelly.....	44	Rose .....	54
Danubio.....	32	Klima .....	26	Seven .....	56
Deluxe.....	64	Klima/cs .....	27	Space .....	40
Detroit.....	10	Magic .....	13	Tiny.....	46
Diamond.....	65	Medea .....	43	Toronto .....	11
Ecoidro .....	18	Miami.....	12	Twin .....	59
Ek 29/45 .....	24	Mimì .....	17	Vanity .....	61
Elite .....	61	Montreal.....	12	Vintage.....	36
Elle .....	68	Moon .....	41	Vogue .....	69
Energy .....	28	Nilo.....	34	Warm .....	26
Esprit .....	13	Norma .....	16	Warm/cs .....	27
Flexa .....	48	Olympia .....	63		
Forma .....	58	Ottawa .....	23		





I sistemi **Leonardo** e **Galileo** gestiscono in **automatico** la combustione del pellet. Rilevano in continuo i principali parametri della combustione, influenzati da:

- **caratteristiche della canna fumaria** (curve, lunghezza, forma, diametro ecc)
- **condizioni ambientali** (vento, umidità, pressione atmosferica, installazione in alta quota, ecc)
- **caratteristiche del pellet** (essenza del legno, compattezza, grado di umidità, ecc) e intervengono di conseguenza per garantire un funzionamento ottimale e risparmio di combustibile.



Stufe a pellet **completamente ermetiche** rispetto all'ambiente di installazione, prelevano l'aria (di combustione e pulizia vetro) direttamente dall'esterno e non dal locale dove sono situate. Consentono di avere aria più pura, massima sicurezza e niente spifferi.

**Ideali nelle moderne case passive** dove il calore è garantito da un alto livello di isolamento termico.



Innovativo **combustore ceramico con catalizzatore** che aumenta la temperatura di combustione garantendo alti rendimenti e abbattendo notevolmente le emissioni in atmosfera.



# TERMOPRODOTTI ad acqua veri e propri sistemi centralizzati, per produrre acqua calda



## A PELLETT

### PRINCIPIO DI FUNZIONAMENTO

Con le calorie prodotte dalla combustione del pellet viene prodotta acqua calda per alimentare l'impianto di riscaldamento ed il circuito sanitario di tutta la casa.

### DOTATE DI:

pompa, vaso espansione chiuso, valvola di sicurezza

### TELECOMANDO/RADIOCOMANDO

#### EASY CONTROL

In alcuni modelli sono previste comode manopole per agevolare l'utilizzo anche da parte di chi non ha dimestichezza con gli apparati tecnologici.

**PROGRAMMAZIONE** È possibile stabilire da pannello sinottico le ore in cui riscaldare la casa .



#### AUTOCLEAN

Dispositivo che attiva la pulizia automatica del crogiolo.

### SEGNALAZIONE DI RISERVA PELLETT

Sul pannello sinottico viene segnalato quando il contenuto di pellet nel serbatoio è tale da consentire il caricamento di un intero sacchetto da 15 kg.

### Predisposizione per ACCENSIONE A DISTANZA

a mezzo combinatore telefonico (optional) o con cronotermostato ambiente.



### PRODUZIONE ACQUA CALDA SANITARIA

I modelli della serie Extra Line sono dotati di **KIT INCORPORATO** per produzione **istantanea** di acqua calda sanitaria. I modelli della serie Top Line, Melody Line, possono produrre acqua calda tramite **accessori optional**.

NB: gli apparati in dotazione sono indicati nelle pagine di presentazione di ogni modello.





## A LEGNA

### PRINCIPIO DI FUNZIONAMENTO (Klima - Warm)

Le termostufe a legna producono acqua calda per alimentare l'impianto di riscaldamento e il circuito sanitario di tutta la casa. L'acqua si riscalda grazie al calore prodotto dalla combustione della legna; successivamente, viene inviata ai termosifoni o ai pannelli radianti a pavimento. Parte del calore viene anche diffuso nel locale di installazione per irraggiamento. Per ottenere acqua calda sanitaria per bagno e cucina, è sufficiente utilizzare appositi kit.

### INSTALLAZIONE

Può essere prevista con vaso di espansione aperto o con vaso di espansione chiuso. In quest'ultimo caso, la termostufa deve essere equipaggiata con serpentina di scarico termico e valvola di sicurezza (versione CS).

Rif. normativa UNI 10412/2.



### SERRANDA FUMI AUTOMATICA

Si apre automaticamente, all'apertura del portello, per consentire l'evacuazione dei fumi dalla canna fumaria senza fuoriuscite nel locale.

**REGOLAZIONE TEMPERATURA ACQUA DI MANDATA** Avviene tramite un termoregolatore che consente di impostare la temperatura richiesta per l'acqua di mandata all'impianto.

### PORTA A CHIUSURA AUTOMATICA

### FACILE PULIZIA DEGLI SCAMBIATORI

### KIT DI INSTALLAZIONE

Edilkamin mette a disposizione 7 kit completi per un'installazione semplice e corretta:

per installazione **A VASO APERTO**

per installazione **A VASO CHIUSO** per stufe con serpentina di scarico termico e valvola di sicurezza (versioni CS)

# TERMOSTUFE A PELLETT

## QUEBEC (24 kW)/DETROIT (33 kW) CERAMICA

Fianchi e top in ceramica panna o rossa.

Dotate di pompa, vaso espansione chiuso e valvola di sicurezza.

	: acciaio/refrattario		: m <sup>3</sup> 625, 860
	: 60 kg		: cm 63x71x126 h
	: 24 - 21 all'acqua, 33 - 29 all'acqua		: telecomando in dotazione
	: 10 cm, maschio		: Kit sanitaria istantanea incorporato

Legenda simboli e dati tecnici pag 70

sistema  
**LEONARDO**  
TECNOLOGIA  
**3** SYSTEM  
COMBUSTIONE  
CERAMICA  
CENTRATA



ceramica rossa



ceramica panna



kW  
24-33







acciaio e ceramica rossa



## TORONTO (24 kW)/BOSTON (33 kW)



ACCIAIO

Fianchi in acciaio e inserti in ceramica panna o rossa.

Dotate di pompa, vaso espansione chiuso e valvola di sicurezza.

-  : acciaio/refrattario
-  : 60 kg
-  : 24 - 21 all'acqua,  
33 - 29 all'acqua
-  : 10 cm, maschio

-  : m<sup>3</sup> 625, 860
-  : cm 63x71x126 h

-  : telecomando in dotazione
-  : Kit sanitaria istantanea incorporato

sistema  
LEONARDO  
TECNOLOGICO

3 SYSTEM  
COMBUSTIONE  
STRANCO  
CATASTICO



acciaio e ceramica panna



Legenda simboli e dati tecnici pag 70

## MONTREAL (24 kW)/MIAMI (33 kW) CERAMICA

**NEW**

sistema  
**LEONARDO**  
TECNOLOGIA

**3** SYSTEM  
COMBUSTIONE  
CERAMICA  
CATALETTO

Fianchi e top in ceramica bordeaux con decoro classico.

Dotate di pompa, vaso espansione chiuso e valvola di sicurezza.

-  : acciaio/refrattario
-  : 60 kg
-  : 24 - 21 all'acqua,  
33 - 29 all'acqua
-  : 10 cm, maschio
-  : m<sup>3</sup> 625, 860
-  : cm 64,5x74x124 h
-  : telecomando in dotazione
-  : Kit sanitaria istantanea incorporato



Legenda simboli e dati tecnici pag 70



kW  
18







**MAGIC**  
acciaio

## MAGIC/ESPRIT

ACCIAIO/PIETRA OLLARE

Fianchi in acciaio grigio con top e inserti in ceramica grigia/  
Fianchi, top e inserti in pietra ollare.

Dotata di pompa, vaso espansione chiuso e valvola di sicurezza.

	: acciaio/ghisa		: m <sup>3</sup> 470
	: 26 kg		: cm 68x60x115 h
	: 18 - 16 all'acqua		: telecomando in dotazione
	: 8 cm, maschio		: Accessori optional



sistema  **LEONARDO**

ESPRIT - pietra ollare



Legenda simboli e dati tecnici pag 70

# TERMOSTUFE A PELLETT

**PRESTIGE**  
CERAMICA

sistema  
**LEONARDO**  
LEONARDO

Fianchi, top e inserti in ceramica rossa, bianco speziato o ambra.

Dotate di pompa, vaso espansione chiuso e valvola di sicurezza.

	: acciaio/ghisa		: m <sup>3</sup> 470
	: 26 kg		: cm 68x60x115 h
	: 18 - 16 all'acqua		: telecomando in dotazione
	: 8 cm, maschio		: Accessori optional



ceramica ambra



Legenda simboli e dati tecnici pag 70

ceramica rossa



kW  
18



**PRESTIGE**  
ceramica bianco speziato

## NORMA

### ACCIAIO

Fianchi in acciaio e alluminio con top e inserti in pietra ollare.



: ghisa



: m<sup>3</sup> 365



: 26 kg



: cm 64x60x115 h



: 14 - 12 all'acqua



: telecomando optional



: 8 cm, maschio



Legenda simboli e dati tecnici pag 70





kW  
14



# MIMÌ

## PIETRA ARENARIA

Fianchi e top in pietra arenaria.



: ghisa



: m<sup>3</sup> 365



: 26 kg



: cm 64x60x115 h



: 14 - 12 all'acqua



: telecomando optional



: 8 cm, maschio









Legenda simboli e dati tecnici pag 70

## ECOIDRO

ACCIAIO

Fianchi in acciaio grigio alluminio, top e inserti ceramica rossa o fianchi in acciaio grigio con inserti ceramica beige.

 : 27 kg	 : m <sup>3</sup> 295
 : 11,3 - 10 all'acqua	 : cm 54x55x95 h
 : 8 cm, femmina	 : telecomando optional

Legenda simboli e dati tecnici pag 70



acciaio grigio



acciaio grigio alluminio



kW  
11,3



ceramica beige

## ECOIDRO

CERAMICA

Fianchi e top in ceramica rosso amaranto o beige.



: 27 kg



: m<sup>3</sup> 295



: 11,3 - 10 all'acqua



: cm 54x55x95 h



: 8 cm, femmina



: telecomando optional



Legenda simboli e dati tecnici pag 70

ceramica rosso amaranto









# TERMOSTUFE A PELLETT

## IDROFLEXA C CERAMICA

NEW

sistema  
GALILEO  
GALILEO

Fianchi e top in ceramica nocciola, rossa o bianco opaco, oppure top in ceramica grigia e fianchi in alluminio grigio.

 : 27 kg	 : m <sup>3</sup> 295
 : 11,3 - 10 all'acqua	 : cm 54,5x55x99 h
 : 8 cm, femmina	 : telecomando Slim (optional)



Legenda simboli e dati tecnici pag 70

top in ceramica grigia, fianchi in alluminio grigio



kW  
11,3



**ceramica bianco opaco**

ceramica nocciola



ceramica rossa



## BASIC



Basic è la caldaia a pellet compatta, di media potenza e dimensioni contenute, installabile in cantina, ma anche in un sottoscala o ripostiglio (nel rispetto delle norme vigenti). Può produrre acqua sanitaria per bagni e cucina con l'impiego di accessori optional.

Dotata di pompa, vaso espansione chiuso e valvola di sicurezza.

**Serbatoio interno** da 60 kg di pellet

**Serbatoio esterno** aggiuntivo (optional) da 250 kg di pellet.

 : acciaio/ghisa

 : m³ 470

 : 60 kg

 : cm 60x56x126 h

 : 18

 : radiocomando in dotazione

 : 8 cm, maschio

 : accessori optional



Legenda simboli e dati tecnici pag 70

## BASIC



## Sistemi automatici di stoccaggio e trasporto pellet per Basic, Ottawa, Atlanta

**NEW**



**Serbatoio da 250 kg,**  
completo di caricatore automatico pellet a coclea (optional)



kW  
24-33



## OTTAWA/ATLANTA

sistema  
LEONARDO  
TECNOLOGICO

3 SYSTEM  
COMBUSTORE  
CERAMICO  
CATALITICO

Ottawa e Atlanta sono caldaie a pellet dalle grandi prestazioni, ideali per chi dispone di un ambiente dedicato. Riscaldano tutta la casa, anche di ampia metratura e funzionano a pellet per una gestione automatica del riscaldamento.

Dotate di: pompa, vaso espansione chiuso, valvola di sicurezza.

**Serbatoio interno** da 100 kg di pellet

**Serbatoio esterno** aggiuntivo (optional) da 250 kg di pellet.

	: acciaio/refrattario		: m³ 625
	: 100 kg		: cm 63x81x126 h
	: 24		: radiocomando in dotazione
	: 10 cm, maschio		: Kit sanitaria istantanea incorporato



Legenda simboli e dati tecnici pag 70





## OTTAWA



## ATLANTA

NEW



	: acciaio/refrattario		: m³ 860
	: 100 kg		: cm 63x81x126 h
	: 33		: radiocomando in dotazione
	: 10 cm, maschio		: Kit sanitaria istantanea incorporato



Legenda simboli e dati tecnici pag 70

## Caldaie policombustibili (adatte anche per agropellet)







Caldaie dalle eccezionali caratteristiche per riscaldare in automatico tutta la casa, funzionando in continuo per molti giorni. Sono programmabili e consentono di risparmiare sui costi del riscaldamento.

### Serbatoio esterno (optional)

disponibile da:

- 65 kg pellet di legno (100 litri)
- 250 kg pellet di legno (400 litri)
- 450 kg pellet di legno (700 litri)

Serbatoio stagionale (su richiesta).

	: acciaio/ materiale ceramico		: m <sup>3</sup> 755
	: 100/400/700 litri		: cm 62x98x144 h
	: 29		: accessori optional
	: 15 cm, maschio		

Legenda simboli e dati tecnici pag 70

## EK 29



## EK 45



	: acciaio/ materiale ceramico		: m <sup>3</sup> 1175
	: 100/400/700 litri		: cm 75x129x163h
	: 45		: accessori optional
	: 16 cm, maschio		

Legenda simboli e dati tecnici pag 70





## Serbatoi per EK 29 e EK 45

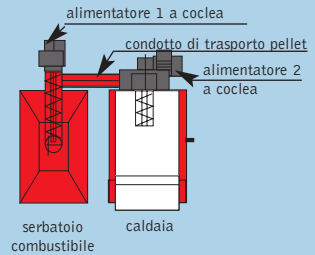
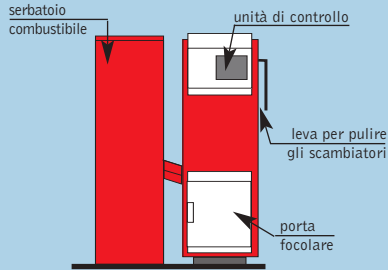

Area occupata dalla caldaia

	X (mm)	Y (mm)
<b>EK 29</b>	614	770
<b>EK 45</b>	744	786

Area serbatoio

	Z (mm)
<b>65 kg</b>	200
<b>250 kg</b>	500
<b>450 kg</b>	750

Area per la manutenzione

	mm (min)
<b>P</b>	700
<b>R</b>	700
<b>S</b>	500

SERBATOIO da 65 kg /100 litri, con coclea da 80 cm

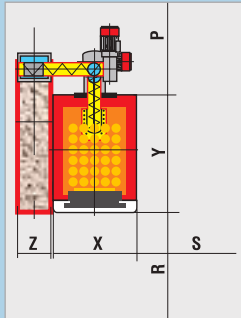

SERBATOIO da 250 kg /400 litri, con coclea da 100 cm

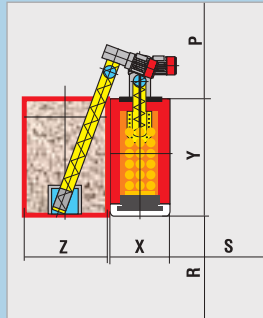

SERBATOIO da 450 kg / 700 litri, con coclea da 120 cm

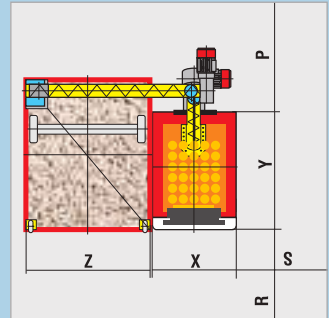

SERBATOIO STAGIONALE (su richiesta)

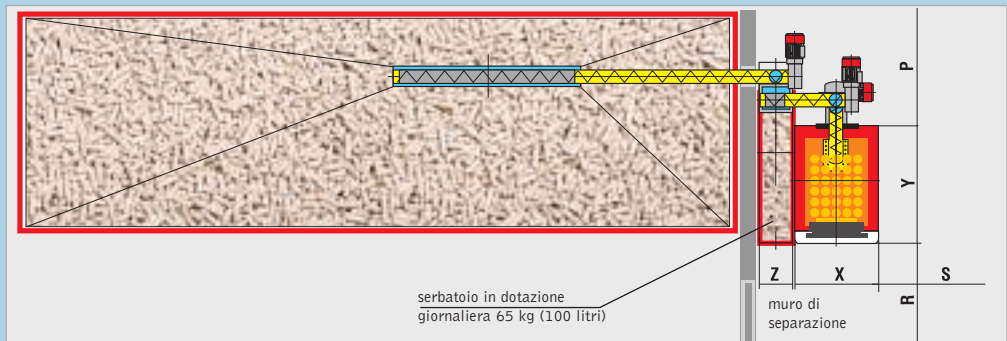

## KLIMA/WARM

PIETRA OLLARE - CERAMICA

### Installazione a vaso aperto

Inserti e top in pietra ollare con fianchi, frontale, basamento in ghisa./  
Inserti e top in ceramica rossa o ambra con fianchi, frontale, basamento  
in ghisa.

Modello base o con scaldavivande.



: acciaio



: m<sup>3</sup> 515



: kW 19,7-11,6 all'acqua



: cm 64x56x108 h - base



: 15 cm, maschio, **superiore**

: cm 64x56x127 h - scaldavivande

Legenda simboli e dati tecnici pag 71

WARM ambra - base



KLIMA scaldavivande



kW  
14



WARM rossa- scaldavivande

## KLIMA CS WARM CS

PIETRA OLLARE - CERAMICA

### Installazione a vaso chiuso

Inserti e top in ceramica rossa o ambra con fianchi, frontale, basamento in ghisa./ Inserti e top in pietra ollare con fianchi, frontale, basamento in ghisa.

Modello base o con scaldavivande.



: acciaio rivestito in scamolex



: m<sup>3</sup> 365



: kW 14-10 all'acqua



: cm 64x56x108 h base



: 15 cm, maschio, **superiore**

: cm 64x56x127 h scaldavivande

Legenda simboli e dati tecnici pag 71



Valvola di sicurezza e serpentina

KLIMA - base



## CALDAIE A LEGNA

Caldaie in ghisa dalla tecnologia avanzata con focolare a geometria regolare che massimizza la carica di combustibile. Garantiscono basse emissioni e un elevato rendimento di combustione. Disponibili appositi kit per trasformazione da versione a vaso aperto in versione a vaso chiuso. Possono produrre acqua sanitaria per bagni e cucina con l'impiego di appositi accessori, optional.

### ENERGY

**TECNOLOGIA A 3 GIRI DI FUMO a tiraggio naturale**

**4 modelli disponibili (21 - 26 - 30 - 34 kW)**

Struttura in ghisa anticorrosione.

Superfici di scambio in ghisa alettate e autopulenti.

Focolare capiente (ciocchi da cm 35).

Termometro per controllare la temperatura della caldaia.

Regolazione frontale aria secondaria.

Antine ambidestre.

Legenda simboli e dati tecnici pag 71

### POWER

**TECNOLOGIA A FIAMMA ROVESCIA**

**(per una lunga durata della carica della legna) a tiraggio forzato tramite ventilatore.**

**PANNELLO SINOTTICO** per la gestione elettronica della caldaia.

**2 modelli disponibili (24 - 33 kW)**

Tiraggio forzato tramite ventilatore.

Minima emissione di agenti inquinanti.

Struttura in ghisa anticorrosione.

Regolazioni con pannello sinottico.

Superfici di scambio in ghisa alettate e autopulenti.

Focolare capiente (ciocchi da cm 35 per mod. 24 kW, cm 50 per mod. 35 kW).

Regolazione frontale aria primaria e secondaria.

Antine ambidestre.

Legenda simboli e dati tecnici pag 71

### ENERGY



### POWER





## 4 MODELLI DISPONIBILI



### ENERGY 21

- Rendimento 64,4 %
- Potenza nominale 21 kW
- Volume riscaldabile 550 m<sup>3</sup> \*  
cm 60x53x96 h

### ENERGY 30

- Rendimento 64 %
- Potenza nominale 30 kW
- Volume riscaldabile 780 m<sup>3</sup> \*  
cm 60x75x96 h

### ENERGY 26

- Rendimento 63,4 %
- Potenza nominale 26 kW
- Volume riscaldabile 680 m<sup>3</sup> \*  
cm 60x63x96 h

### ENERGY 34

- Rendimento 64 %
- Potenza nominale 34 kW
- Volume riscaldabile 885 m<sup>3</sup> \*  
cm 60x85x96 h

#### optional:

Serpentina e valvola di sicurezza per installazione a vaso chiuso

\* a seconda del tipo d'impianto e isolamento (come da L 10/91 e successive modifiche)

## 2 MODELLI DISPONIBILI



### POWER 24

- Rendimento 78,4 %
- Potenza nominale 24 kW
- Volume riscaldabile 625 m<sup>3</sup> \*  
cm 70x90x135 h

### POWER 33

- Rendimento 77,1 %
- Potenza nominale 33 kW
- Volume riscaldabile 860 m<sup>3</sup> \*  
cm 70x110x135 h

#### optional:

Serpentina e valvola di sicurezza per installazione a vaso chiuso

\* a seconda del tipo d'impianto e isolamento (come da L 10/91 e successive modifiche)

**STUFE** ad aria,  
economiche, ecologiche, per un calore diffuso anche in più locali



## A PELLETTA

### PRINCIPIO DI FUNZIONAMENTO

Le stufe sono progettate per produrre aria calda che può essere convogliata:

- nel locale di installazione tramite griglia frontale
- negli ambienti limitrofi tramite canalizzazione con tubi  $\varnothing$  10 cm collegati ad appositi bocchettoni. (Tiny, Kelly, Simpaty Line, Top Line, Melody Line).

La distribuzione dell'aria calda negli ambienti avviene tramite ventilatore. Peculiarità della combustione a pellet è la grande autonomia di funzionamento, anche di più giorni senza necessità di ricarica.

Nell'ambito delle funzioni della scheda elettronica sono operanti il "**Sistema Leonardo**"<sup>®</sup> e il "**Sistema Galileo**".

**INSTALLAZIONE** anche non in asse con la canna fumaria.

**AUTOCLEAN** attiva la pulizia automatica del crogiolo.

### PROGRAMMAZIONE

È possibile impostare da pannello sinottico le ore in cui riscaldare la casa.

### TELECOMANDO/ RADIOCOMANDO

**Predisposizione per ACCENSIONE A DISTANZA** a mezzo combinatore telefonico (optional) o con cronotermostato ambiente.

### EASY CONTROL

In alcuni modelli sono previste comode manopole per agevolare l'utilizzo anche da parte di chi non ha dimestichezza con gli apparati elettronici.

### SEGNALAZIONE "RISERVA PELLETTA"

Sul pannello sinottico viene segnalato quando il contenuto di pellet nel serbatoio è tale da consentire il caricamento di 1 intero sacchetto da 15 kg.

**NB:** gli apparati in dotazione sono indicati nelle pagine di presentazione di ogni modello.



## A LEGNA

### PRINCIPIO DI FUNZIONAMENTO

Le stufe sono progettate per la produzione di aria calda che può essere convogliata:

- nel locale di installazione tramite la griglia frontale;
- negli ambienti limitrofi tramite canalizzazione (modelli Chic, Elite e Vanity) con tubi di  $\varnothing$  10 cm collegati ad appositi bocchettoni sullo schienale\* (foto **A**).

L'aria calda è ottenuta facendo transitare l'aria ambiente, prelevata tramite griglia alla base della stufa, in apposita intercapedine perimetrale al focolare.

La circolazione dell'aria calda negli ambienti può avvenire a convezione naturale **N** o a ventilazione forzata **V** ed è gestita tramite pannello sinottico.

**A.**



### ARIA DI COMBUSTIONE

- **primaria:** è immessa alla base del focolare, determinante per la prima fase di combustione;
- **secondaria e pulizia vetro:** realizza una lama d'aria che lambisce la fascia interna del vetro mantenendolo pulito e completa la prima fase di combustione.
- **terziaria o di post-combustione** (prevista su alcuni modelli): è immessa preriscaldata dallo schienale del focolare (foto **B**) o a pioggia dall'alto e innesca una seconda fase che consente di reincondire gli incombusti residui della combustione primaria, ancora presenti nei fumi.

**B.**





## STUFE A PELLETT

### DANUBIO



Fianchi in acciaio grigio con top e inserti in ceramica grigia.

	: ghisa		: m³ 345
	: 23,5 kg		: cm 68x53x115 h
	: 13,2		: telecomando in dotazione
	: 8 cm, maschio		: <b>canalizzabile totalmente</b> (kit 11 e 11BIS, optional)



Legenda simboli e dati tecnici pag 72

### RIO

Fianchi, top e inserti in pietra ollare.





kW  
13,2





**DANUBIO**  
acciaio

# STUFE A PELLETT

**NILO**  
CERAMICA

sistema  
**LEONARDO**  
TECNOLOGIA

Fianchi, top e inserti in ceramica rossa, bianco speziato o ambra.

- |  |                 |   |   |
|--|-----------------|---|---|
|  | : ghisa         |  | : m <sup>3</sup> 345  |
|  | : 23,5 kg       |  | : cm 68x53x115 h  |
|  | : 13,2          |  | : telecomando in dotazione                                      |
|  | : 8 cm, maschio |  | : <b>canalizzabile totalmente</b><br>(kit 11 e 11BIS, optional) |



Legenda simboli e dati tecnici pag 72

ceramica rossa



kW  
13,2

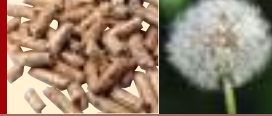

**NILO**  
ceramica bianco speziato

ceramica ambra



## STUFE A PELLETT

# VINTAGE **NEW**

CERAMICA

sistema  
**LEONARDO**

ceramica rossa



Fianchi, top e inserti in ceramica rossa o bianco speziato.



: ghisa



: m<sup>3</sup> 285



: 19 kg



: cm 63x54x107 h



: 11



: telecomando in dotazione



: 8 cm, maschio



: **canalizzabile totalmente**  
(kit 10 e 10BIS, optional)



Legenda simboli e dati tecnici pag 72

ceramica bianco speziato





top e inserti in ceramica rossa



top e inserti in ceramica grigia

# FUNNY

## ACCIAIO

sistema  
**LEONARDO**  
LEONARDO

Fianchi in acciaio grigio, top e inserti in ceramica grigia, bianco panna o rossa.

 : ghisa

 : 19 kg

 : 11

 : 8 cm, maschio

 : m<sup>3</sup> 285

 : cm 62x56x107 h

 : telecomando in dotazione

 : **canalizzabile totalmente**  
(kit 10 e 10BIS, optional)



top e inserti in ceramica bianco panna



Legenda simboli e dati tecnici pag 72

# STUFE A PELLETT

## CHERIE

CERAMICA

sistema  
**LEONARDO**  
TECNOLOGIA

ceramica rossa

Fianchi, top e inserti in ceramica nocciola, bianco panna o rossa.

- |  |   |
|--|---|
|  : ghisa         |  : m³ 285  |
|  : 19 kg         |  : cm 62x56x107 h  |
|  : 11            |  : telecomando in dotazione                                      |
|  : 8 cm, maschio |  : <b>canalizzabile totalmente</b><br>(kit 10 e 10BIS, optional) |



Legenda simboli e dati tecnici pag 72

ceramica nocciola



kW  
11



**CHERIE**  
ceramica bianco panna

# STUFE A PELLETT

## SPACE

PIETRA ARENARIA

sistema  
**LEONARDO**<sup>®</sup>

Fianchi e top in pietra arenaria.

 : ghisa	 : m <sup>3</sup> 285
 : 19 kg	 : cm 62x56x107 h
 : 11	 : telecomando in dotazione
 : 8 cm, maschio	 : <b>canalizzabile totalmente</b> (kit 10 e 10BIS, optional)



Legenda simboli e dati tecnici pag 72





kW  
11











# MOON

PIETRA OLLARE

sistema  
LEONARDO<sup>®</sup>  
LEONARDO

Fianchi e top in pietra ollare.

- |   |   |
|---|---|
|  : ghisa         |  : m <sup>3</sup> 285  |
|  : 19 kg         |  : cm 62x56x107 h  |
|  : 11            |  : telecomando in dotazione                                      |
|  : 8 cm, maschio |  : <b>canalizzabile totalmente</b><br>(kit 10 e 10BIS, optional) |



Legenda simboli e dati tecnici pag 72

# STUFE A PELLETT

## AIDA\*

PIETRA ARENARIA

Fianchi e top in pietra arenaria.

	: ghisa		: m <sup>3</sup> 260
	: 29 kg		: cm 64x54x115 h
	: 10		: telecomando in dotazione
	: 8 cm, maschio		: <b>canalizzabile</b> (kit 8, optional)



Legenda simboli e dati tecnici pag 72

\* fino esaurimento scorte



**kW  
10**

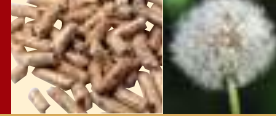

## MEDEA\*

ACCIAIO

Fianchi in acciaio e alluminio con top e inserti in pietra ollare.

- |   |   |
|---|---|
|  : ghisa         |  : m <sup>3</sup> 260                        |
|  : 29 kg         |  : cm 64x54x115 h                            |
|  : 10            |  : telecomando in dotazione                  |
|  : 8 cm, maschio |  : <b>canalizzabile</b><br>(kit 8, optional) |



Legenda simboli e dati tecnici pag 72

\* fino esaurimento scorte

# STUFE A PELLETT

## KELLY

**NEW**

ACCIAIO

Rivestimento in acciaio bordeaux o grigio perla.

	: ghisa		: m³ 235
	: 20 kg		: cm 83x26x118 h
	: 9		: telecomando optional
	: 8 cm, maschio		: <b>canalizzabile</b> (kit 8, optional)



Legenda simboli e dati tecnici pag 72

acciaio grigio perla



### Il massimo del calore nel minimo spessore

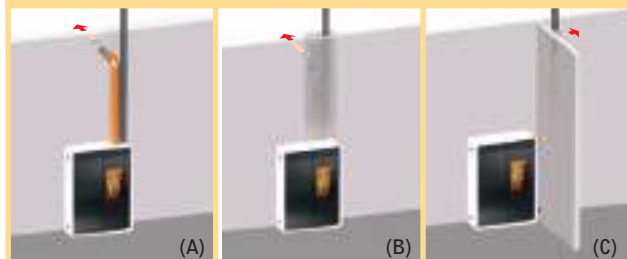

offre la possibilità di scegliere l'uscita fumi e l'uscita aria calda in base alle proprie esigenze di installazione: dal top (A), dal retro (B), dal fianco (C).



**kW  
9**



**KELLY**  
acciaio bordeaux

# STUFE A PELLETT

**TINY**  
CERAMICA

**NEW**

sistema  
**LEONARDO**

Rivestimento in ceramica/acciaio bianco opaco, rossa o nera.

	: ghisa		: m³ 235
	: 20 kg		: cm 89x26x123 h
	: 9		: radiocomando in dotazione
	: 8 cm, maschio		: <b>canalizzabile</b> (kit 8, optional)



Legenda simboli e dati tecnici pag 72

ceramica rossa



ceramica nera



## Il massimo del calore nel minimo spessore

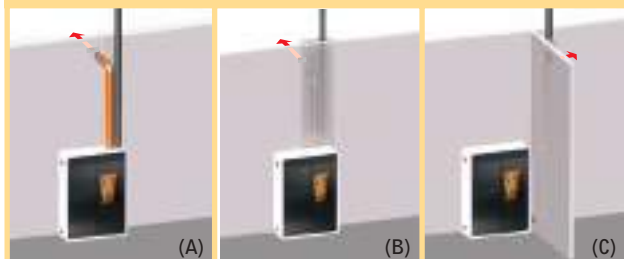

offre la possibilità di scegliere l'uscita fumi e l'uscita aria calda in base alle proprie esigenze di installazione: dal top (A), dal retro (B), dal fianco (C).



kW  
9



**TINY**  
ceramica bianco opaco

# STUFE A PELLETT

## FLEXA

**NEW**

sistema  
**GALILEO**

CERAMICA / ACCIAIO

Fianchi e top in ceramica bianco opaco, rossa o nocciola e fianchi in alluminio grigio e top in ceramica grigia.

 : ghisa

 : m<sup>3</sup> 210

 : 20 kg

 : cm 54,5x55x99 h

 : 8

 : telecomando Slim optional

 : 8 cm, maschio



Legenda simboli e dati tecnici pag 72

**ceramica bianco opaco**





kW  
8



**FLEXA**  
ceramica rossa

alluminio grigio e top in ceramica grigia



ceramica nocciola



## IRIS UP

CERAMICA

**La stufa più accesa in Europa!**

Fianchi e inserti in ceramica grigia, bordeaux o tortora.

 : ghisa

 : m<sup>3</sup> 210

 : 15 kg

 : cm 60x49x94 h

 : 8

 : telecomando optional

 : 8 cm, maschio



Legenda simboli e dati tecnici pag 72

ceramica grigia



ceramica bordeaux



**kW**  
**8**



**IRIS UP**  
ceramica tortora

## IRIS PLUS

CERAMICA / PIETRA OLLARE

**Nata da Iris, destinata al successo!**

Fianchi e inserti in ceramica bordeaux, albicocca, panna o grigia.

Fianchi e inserti in pietra ollare.

 : ghisa

 : m<sup>3</sup> 210

 : 15 kg

 : cm 60x53x95 h

 : 8

 : telecomando optional



 : 8 cm, maschio

Legenda simboli e dati tecnici pag 72

pietra ollare



kW  
8



**IRIS PLUS**  
ceramica bordeaux

ceramica panna



ceramica albicocca



ceramica grigia



# STUFE A PELLETT

## ROSE\*

CERAMICA / ACCIAIO

Fianchi e top in ceramica rosso amaranto o beige.  
Fianchi in acciaio grigio con inserti in ceramica rosso amaranto.

 : ghisa

 : 20 kg

 : 8

 : 8 cm, maschio

 : m<sup>3</sup> 210

 : cm 54x51x95 h

 : telecomando optional



Legenda simboli e dati tecnici pag 72

\* fino esaurimento scorte

ceramica beige



ceramica rosso amaranto



kW  
8



**ROSE**  
acciaio

# STUFE A PELLETT

## SEVEN

### INSERTI CERAMICA

Fianchi in acciaio verniciato, top e inserti in ceramica di diversi colori.

 : ghisa

 : 15 kg

 : 7

 : 8 cm, maschio

 : m<sup>3</sup> 180

 : cm 46x54x96 h

 : telecomando optional



Legenda simboli e dati tecnici pag 72

fianchi in acciaio verniciato grigio, top e inserti in ceramica grigia





**kW  
7**

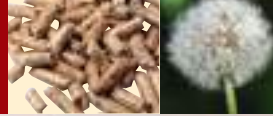

## SEVEN

fianchi in acciaio verniciato bordeaux,  
top e inserti in ceramica bordeaux

fianchi in acciaio verniciato grigio, top e inserti in ceramica bianca



fianchi in acciaio verniciato grigio, top e inserti in ceramica cuoio



# STUFE A PELLETT









## FORMA ACCIAIO/CERAMICA

**NEW**

sistema  
**LEONARDO**

**PH**  
calore per la  
CASA PASSIVA

Rivestimento in acciaio, frontale in ceramica avorio effetto legno.

 : ghisa-acciaio	 : 8 cm, maschio
 : 15 kg	 : m <sup>3</sup> 155
 : 6	 : cm 53,5x62x93 h
 : si	 : telecomando in dotazione
 : si	



Legenda simboli e dati tecnici pag 72



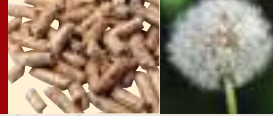









**TWIN**  
STONELITE

**NEW**

sistema  
**LEONARDO**  
LEONARDO

**PH**  
calore per la  
CASA PASSIVA

Rivestimento in stonelite marrone chiaro.

- |   |  |
|---|--|
|  : ghisa-acciaio |  : 8 cm, maschio            |
|  : 15 kg         |  : m <sup>3</sup> 155       |
|  : 6             |  : cm 50x54,5x95,5 h        |
|  : si            |  : telecomando in dotazione |
|  : si            |  |



Legenda simboli e dati tecnici pag 72

# STUFE A LEGNA

## CHIC

### CERAMICA

Fianchi, top e inserti in ceramica rossa, bianco speziato o ambra.

 : ecokeram®

 : 9,6(N)-9,7(V)

 : si

 : si

 : 15 cm, maschio, **superiore-posteriore**

 : m³ 250(N)-255(V)

 : cm 68x53x115 h

 : **canalizzabile**  
(kit 8, optional)

Legenda simboli e dati tecnici pag 73

ceramica rossa



ceramica bianco speziato



ceramica ambra



kW  
9,6











ELITE

## ELITE/VANITY

ACCIAIO/PIETRA OLLARE

Fianchi in acciaio grigio con top e inserti in ceramica grigia.

	: ecokeram®		: 15 cm, maschio, <b>superiore-posteriore</b>
	: 9,6(N)-9,7(V)		: m <sup>3</sup> 250(N)-255(V)
	: si		: cm 68x53x115 h
	: si		: <b>canalizzabile</b> (kit 8, optional)

Legenda simboli e dati tecnici pag 73

VANITY



# STUFE A LEGNA

## IRIS LEGNA

CERAMICA

Fianchi, top e inserti in ceramica bordeaux o albicocca.

 : ghisa

 : 7,8

 : si

 : 13 cm, maschio, **superiore**

 : m<sup>3</sup> 205

 : cm 60x48x94 h

Legenda simboli e dati tecnici pag 73

ceramica albicocca



ceramica bordeaux



kW  
7,8



# OLYMPIA

PIETRA OLLARE

Fianchi, top e inserti in pietra ollare.



: scamolex



: 7,8



: si



: 13 cm, maschio, **superiore**



: m<sup>3</sup> 205



: cm 60x48x94 h

Legenda simboli e dati tecnici pag 73

## DELUXE

NEW

ACCIAIO

Rivestimento in acciaio verniciato.

**GIREVOLE A 360°.**



: vermiculite



: 15 cm, femmina, **superiore-posteriore**



: 7



: m<sup>3</sup> 180



: si



: cm 60x44x110 h

Legenda simboli e dati tecnici pag 73





kW  
7









# DIAMOND

**NEW**

ACCIAIO

Rivestimento in acciaio verniciato con portello in vetro serigrafato.

	: vermiculite		: 15 cm, femmina, <b>superiore-posteriore</b>
	: 7		: m <sup>3</sup> 180
	: sì		: cm 60x44x119 h







Legenda simboli e dati tecnici pag 73

## ROLLER

ACCIAIO

Rivestimento in acciaio verniciato, top e inserti in alluminio lucido.

**GIREVOLE A 360°.**

	: refrattario		: 15 cm, femmina, <b>superiore</b>
	: 6		: m <sup>3</sup> 155
	: si		: cm 51x51x125 h

Legenda simboli e dati tecnici pag 73



**kW  
6**



**acciaio**







# STUFE A LEGNA

## ELLE

ACCIAIO

Rivestimento in acciaio verniciato, top e inserti in alluminio lucido.

**CON 3 LATI VETRATI.**

	: refrattario		: 15 cm, femmina, <b>superiore-posteriore</b>
	: 6		: m <sup>3</sup> 155
	: si		: cm 54x57x112 h

Legenda simboli e dati tecnici pag 73

particolare con uscita fumi posteriore



uscita fumi superiore



kW  
6



## VOGUE

ACCIAIO

Rivestimento in acciaio verniciato bi-colore: grigio e grigio antracite.

 : refrattario

 : 6

 : si

 : 15 cm, femmina, **superiore-posteriore**





















 : m<sup>3</sup> 155

 : cm 56x56x118 h



















cassetto legna / vano portaoggetti





























Legenda simboli e dati tecnici pag 73

		<b>ECOIDRO IDROFLEXA C</b>	<b>MIMÌ NORMA</b>	<b>ESPRIT MAGIC PRESTIGE</b>	<b>TORONTO QUEBEC MONTREAL</b>	<b>BOSTON DETROIT MIAMI</b>	<b>BASIC</b>	<b>OTTAWA</b>	<b>ATLANTA</b>	<b>EK 29 EK 45</b>
 Dimensioni LxPxH cm	54x55x95 54,5x54x98	64x60x115	68x60x115	63x71x126 63x71x126 64,5x74x124	63x71x126 63x71x126 64,5x74x124	60x56x126	63x81x126	63x81x126	62x98x144 75x129x163	
 kg Serbatoio pellet	27	26	26	60	60	60	100	100	esterno 100/400 700 litri	
 kW Potenza nominale	11,3 (all'acqua)	14 (all'acqua)	18 (all'acqua)	24 (all'acqua)	33 (all'acqua)	18	24	33	29-45	
 kW min-max Potenza	3,4-11,3	4,5-14	5,6-18	7,5-24	10-33	6,1-18	7,5-24	10-33	8-29 13,5-45	
 kg/h min-max Consumo	0,8-2,7	1,0-3,0	1,2-4,1	1,8-5,7	2,5-7,8	1,0-4,0	1,7-5,7	2,5-7,8	2,0-6,8 3,7-12,5	
 h min-max Autonomia	10-33	8,5-26	6,3-21,5	10,5-33	7,7-24	15-60	17-58	13-40	-	
 m <sup>3</sup> Volume riscaldabile*	295	365	470	625	860	470	625	860	755 1175	
 % Rendimento	90,1	90,4	91,94	90,1	90,1	92,7	91,7	90,1	92,2 91	
 cm Uscita fumi M/F	Ø 8 F	Ø 8 M	Ø 8 M	Ø 10 M	Ø 10 M	Ø 8 M	Ø 10 M	Ø 10 M	Ø 15 M Ø 16 M	
 kg Peso con imballo	170-204 188	333 299	305 270 295	370 390 360	370 390 360	258	355	370	430 562	
 Sistema Leonardo® Sistema Galileo	SG		SL	SL	SL	SL	SL	SL		
 Easy control: regolazione di potenza e ventilazione tramite manopole.	•	•	•	•	•	•	•	•		
 Fire control: modula automaticamente la combustione per evitare sprechi di combustibile.		•	•	•	•	•	•	•		
 Autoclean: pulizia auto- matica crogliolo	•	•	•	•	•	•	•	•		
 Pannello sinottico	•	•	•	•	•	•	•	•	•	
 Predisposizione gestione a distanza a mezzo telefono o cronotermostato	•	•	•	•	•		•	•	optional	
 Funzionamento Automatico o Manuale										
 Confort clima: la stufa si spegne al raggiungi- mento della temperatura ambiente desiderata.					•	•		•		
 Autocheck a freddo: permette di individuare im- mediatamente eventuali incon- venienti.	•	•	•	•	•	•	•	•	•	
 Programmatore orario: accensione/spengimento all'orario desiderato.	•	•	•	•	•	•	•	•		
 Canalizzazione aria calda nel locale adiacente										
 litri Contenuto d'acqua	6	28	28	80	80	28	80	80	70 105	
 Impianto valvola sovrapressione incorporata			•	•	•	•	•	•		
 Pompa di circolazione	15/50	25/50	25/50	15/50	15/50	15/50	15/50	15/50		

\* a seconda del tipo di impianto e isolamento (come da L 10/91 e successive modifiche)



















	<b>KLIMA CS WARM CS</b> base	<b>KLIMA CS WARM CS</b> scaldavivande	<b>KLIMA WARM</b> base	<b>KLIMA WARM</b> scaldavivande	<b>ENERGY</b> 21 26 30 34	<b>POWER</b> 24 33
 Dimensioni LxPxH cm	64x56x108	64x56x127	64x56x108	64x56x127	60x53x96 60x63x96 60x75x96 60x85x96	70x90x135 70x110x135
 kW Potenza nominale	14 10 all'acqua	14 10 all'acqua	19,7 11,6 all'acqua	19,7 11,6 all'acqua	21 26 30 34	24 33
 kW kW min-max Potenza	5-16	5-16	6,5-22	6,5-22	10-21 13-26 15-30 17-34	12-24 16-33
 kg/h min-max Consumo	1,7-5,3	1,7-5,3	2,2-7,5	2,2-7,5	2,9-7,8 4,8-9,6 5,6-11,2 6,5-13	3,5-7 4,7-9,7
 m <sup>3</sup> Volume riscaldabile*	365	365	515	515	550 680 780 885	625 860
 % Rendimento	81,6	81,6	80,7	80,7	64,4 63,38 64 64	78,4 77,1
 cm Uscita fumi M/F	Ø 15 M	Ø 15 M	Ø 15 M	Ø 15 M	Ø 18 M	Ø 15
 kg Peso con imballo	278 253	308 276	275 250	305 274	273 319 389 416	495 606
 Regolazione automatica dell'aria di combustione						
 Pannello sinottico						•
 Canalizzazione aria calda nel locale adia- cente						
 Funzionamento Automatico o Manuale						
 Uscita fumi posteriore						
 Uscita fumi superiore	•	•	•	•		
 Convezione naturale						
 Ventilazione forzata						
 Cassetto cenere						

\* a seconda del tipo di impianto e isolamento (come da L 10/91 e successive modifiche)

		FORMA TWIN	SEVEN	IRIS PLUS IRIS UP	ROSE	FLEXA	TINY KELLY	AIDA MEDEA	VINTAGE
	Dimensioni LxPxH cm	53,5x62x93 50x54,5x95,5	46x54x96	60x53x95 60x49x94	54x51x95	54,5x55x99	89x26x123 83x26x118	64x54x115	63x54x107
	kg Serbatoio pellet	15	15	15	20	20	20	29	19
	kW Potenza nominale	6	7	8	8	8	9	10	11
	kW min-max Potenza	2-6	2,1-7	3,4-8	3,4-8	3,4-8	2,6-9	3-10	5,5-11
	kg/h min-max Consumo	0,5-1,6	0,6 -1,7	0,9-2,0	0,9-2,0	0,9-2	0,9-2,1	0,7-2,2	0,7-2,6
	h min-max Autonomia	9-30	8,5-25	7,5-17	10-22	10-22	9,5-22	13-41	7,5-27
	m³ Volume riscaldabile*	155	180	210	210	210	235	260	285
	Rendimento	90,1	89,2	89,2	89,2	90,1	90,1	89,2	90,06
	cm Uscita fumi M/F	Ø 8 M	Ø 8 M	Ø 8 M	Ø 8 M	Ø 8 M	Ø 8 M	Ø 8 M	Ø 8 M
	kg Peso con imballo	152 180	165	157 160	159 187	204	217 190	310-311 280-281	250
	Sistema Leonardo® Sistema Galileo	SL	SL			SG	SL -		SL
	Easy control: regolazione di potenza e ventilazione tramite manopole.		•	•	•	•		•	•
	Fire control: modula automaticamente la combustione per evitare sprechi di combustibile.	•	•	•	•		•	•	•
	Autoclean: pulizia automatica crogiolo	•	•	•	•	•	•	•	•
	Pannello sinottico	•	•	•	•	•	•	•	•
	Predisposizione gestione a distanza a mezzo telefono o cronotermostato	•	•	•	•		•	•	•
	Funzionamento Automatico o Manuale	•	•	•	•	•	•	•	•
	Confort clima: la stufa si spegne al raggiungimento della temperatura ambiente desiderata.	•	•	•			•	•	•
	Autocheck a freddo: permette di individuare immediatamente eventuali inconvenienti.	•	•	•			•	•	•
	Programmatore orario: accensione/spengimento all'orario desiderato.	•	•	•	•	•	•	•	•
	Canalizzazione aria calda nel locale adiacente						•	•	•
	litri Contenuto d'acqua								
	Convezione naturale (N)	•							
	Ventilazione forzata (V)	•							

\* a seconda del tipo di impianto e isolamento (come da L 10/91 e successive modifiche)



CHERIE SPACE MOON FUNNY	DANUBIO RIO NILO			ELLE	VOGUE	ROLLER	DELUXE	DIAMOND	IRIS LEGNA	OLYMPIA	CHIC ELITE VANITY
62x56x107	68x53x115		Dimensioni LxPxH cm	54x57x112	56x56x118	51x51x125	60x44x110	60x44x119	60x48x94	60x48x94	68x53x115
19	23,5			kW Potenza nominale	6	6	6	7	7	7,8	7,8
11	13,2			kW min-max Potenza	3-7	3-7	3-7	2,8-7,5	2,8-7,5	3-10	3-10
5,5-11	5,1-13,2			kg/h min-max Consumo	1,0-2,0	1,0-2,0	1,0-2,0	1-2,2	1-2,2	1,0-3,0	1,0-3,0
0,7-2,6	1,1-2,9			m <sup>3</sup> Volume riscaldabile*	155	155	155	180	180	205	205
285	345			Rendimento	81,95	81,95	81,95	80,8	80,8	79,2	79,2
90,06	92,5			cm Uscita fumi M/F	Ø 15 F	Ø 15 F	Ø 15 F	Ø 15 F	Ø 15 F	Ø 13 M	Ø 13 M
Ø 8 M	Ø 8 M			kg Peso con imballo	157	171	177	156	165	140	152
227 233 243 207	240 277 262			Regolazione automa- tica dell'aria di combustione	•	•	•				
SL	SL			Pannello sinottico							
•	•			Canalizzazione aria calda nel locale adiacente							
•	•			Funzionamento Automatico o Manuale	•	•	•				
•	•			Uscita fumi posteriore	•	•					
•	•			Uscita fumi superiore	•	•	•			•	•
•	•			Convezione naturale	•	•	•			•	•
				Ventilazione forzata				•	•		
				Cassetto cenere	•	•	•			•	•

\* a seconda del tipo di impianto e isolamento (come da L 10/91 e successive modifiche)

Per maggiori informazioni o per consultare le schede tecniche dei prodotti  
visitate il nostro sito [www.edilkamin.com](http://www.edilkamin.com)



**Idroflexa C**

**Ecoidro**

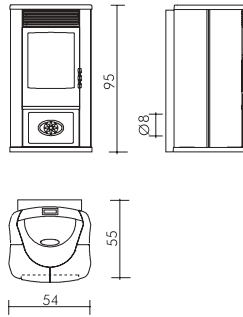
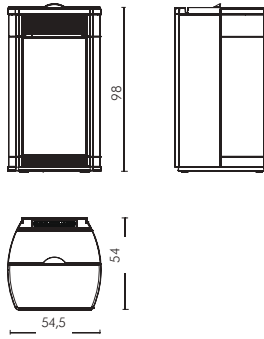

**MELODY LINE  
Mimi - Norma**

**TOP LINE  
Esprit-Magic-Prestige**

**EXTRA LINE  
Montreal-Miami**

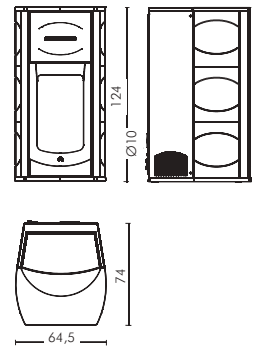
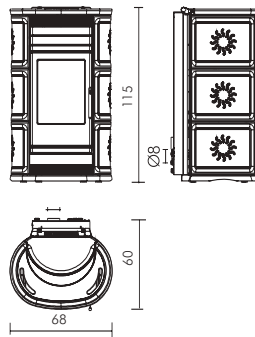
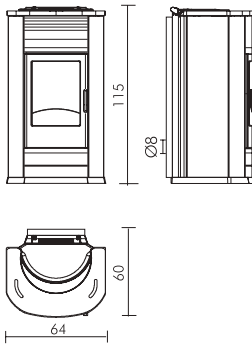

**EXTRA LINE  
Boston-Detroit-Toronto-Quebec**

**TOP LINE  
Basic**

**EXTRA LINE  
Ottawa-Atlanta**

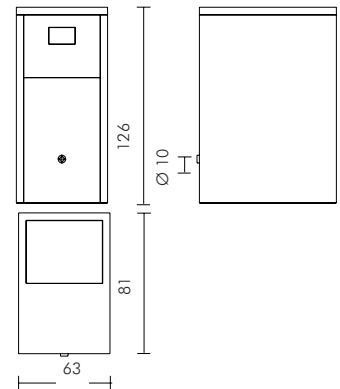
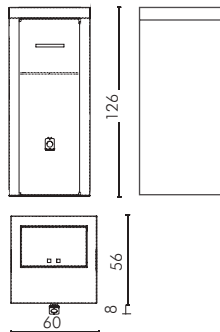
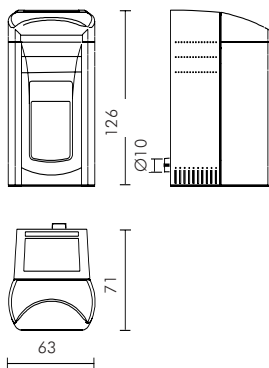

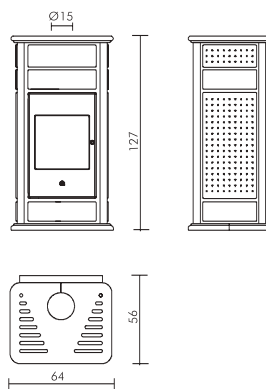
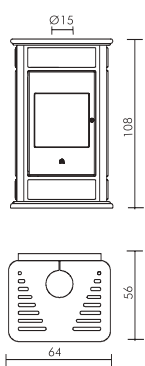



**Forma**

**Twin**

**Seven**

**Flexa**

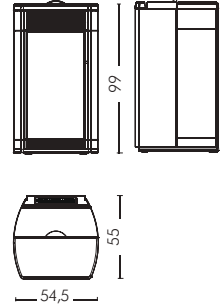
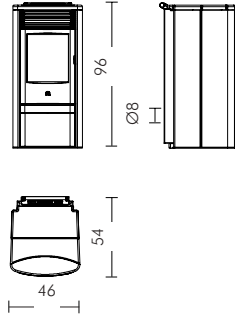
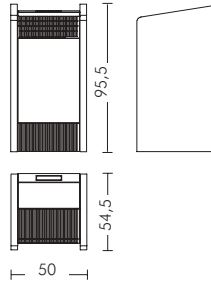
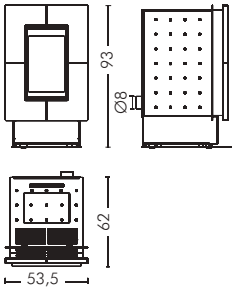

**Rose**

**Iris plus/  
Iris up**

**Tiny**

**Kelly**

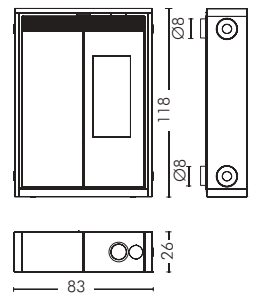
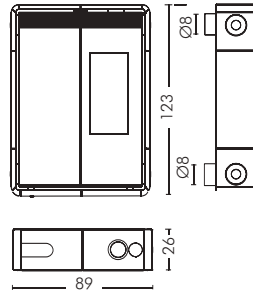
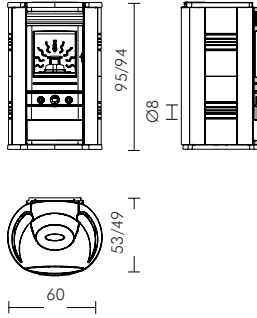
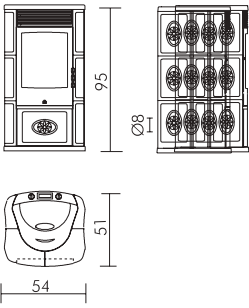

**MELODY LINE  
Aida - Medea**

**SIMPATY LINE  
Cherie-Funny-Moon-Space**

**SIMPATY LINE  
Vintage**

**EVOLUTION LINE  
Danubio-Rio-Nilo**

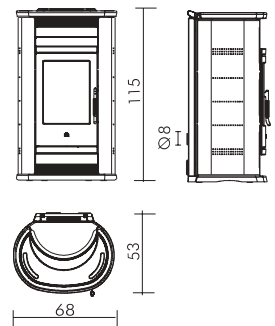
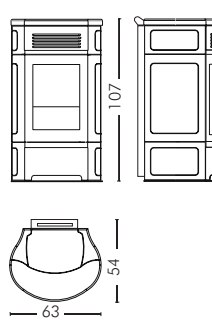
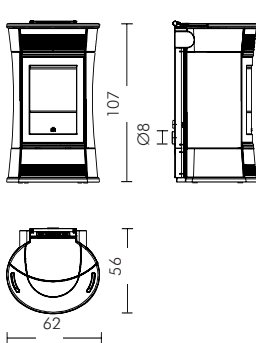
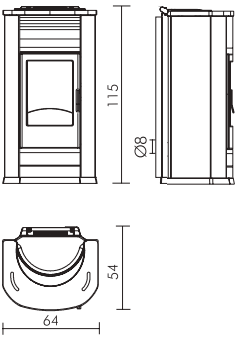

**EVOLUTION LINE**  
Chic -Elite -Vanity

**Iris legna**

**Olympia**

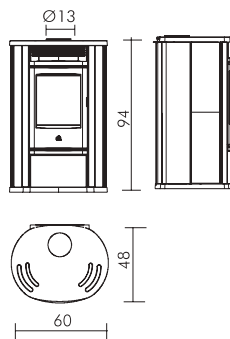
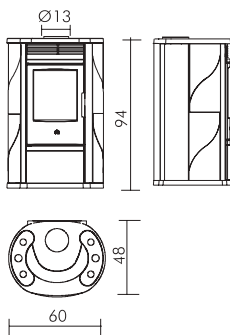
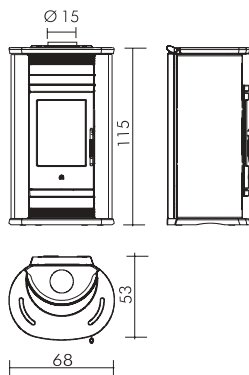

**STYLO LINE**  
Roller

**STYLO LINE**  
Vogue

**STYLO LINE**  
Elle

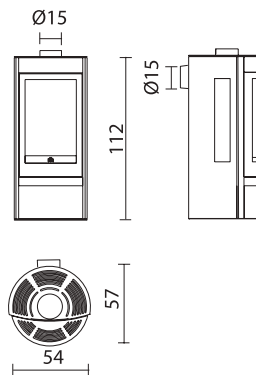
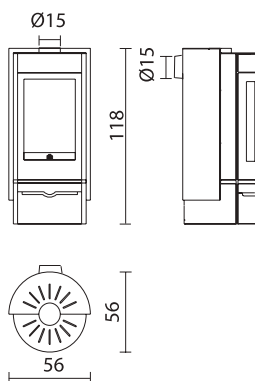
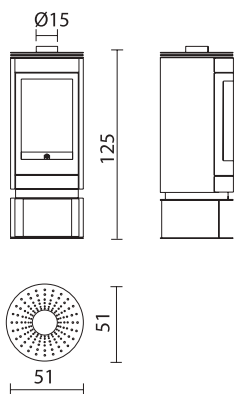

**Deluxe**

**Diamond**

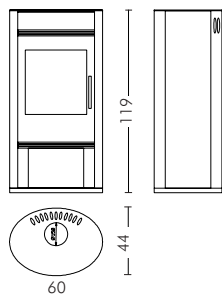
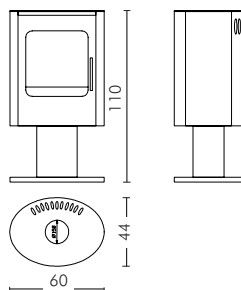

## CANNE FUMARIE a doppia parete coibentate PER ESTERNO per stufe a pellet

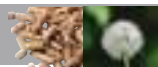

parete esterna in **rame** Ø cm 10 - parete interna in **inox** aisi 316/L Ø cm 8

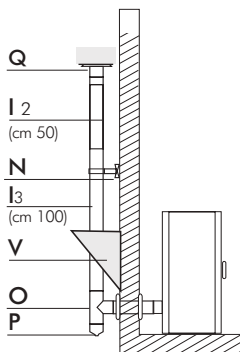

SCHEMA D'INSTALLAZIONE BASE

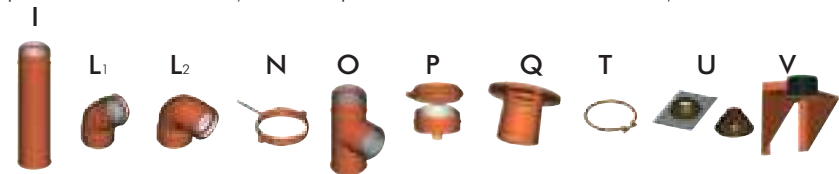

parete esterna in **alluminio verniciato marrone** Ø cm 10 - parete interna in **inox** aisi 316/L Ø cm 8

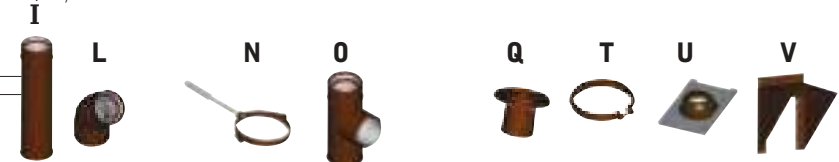

- (I) spezzone canna cm 25/50/100
- (L) curva 45° - 90°

- (N) collare fissaggio a parete
- (O) raccordo a T
- (P) tappo con scarico condensa

- (Q) terminale scarico fumi
- (T) fascetta
- (V) supporto a muro

- (U) tegola con calotta inf. e calotta sup.

## CANNE FUMARIE monoparete PER INTERNO per stufe e termostufe a pellet

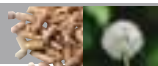

monoparete in **inox** aisi 316/L Ø cm 8 - complete di guarnizione

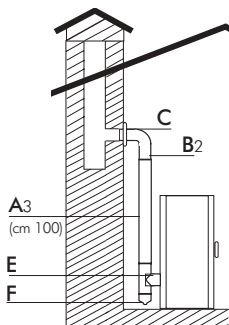

SCHEMA D'INSTALLAZIONE BASE

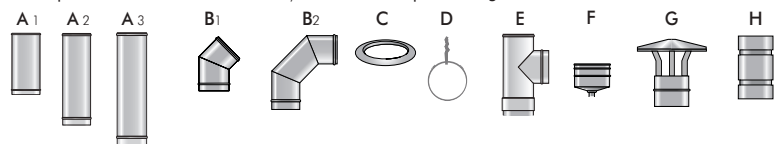

monoparete in **inox** aisi 316/L **verniciato nero** Ø cm 8-complete di guarnizione, da montare senza fascette

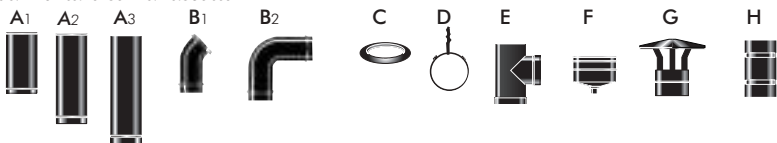

- (A1) spezzone canna cm 25
- (A2) spezzone canna cm 50
- (A3) spezzone canna cm 100
- (B1) curva 45°

- (B2) curva 90°
- (C) rosone a parete
- (D) collare fissaggio a parete
- (E) raccordo a T maschio (per Ecoldra, Idroflessa)

- (F) tappo senza scarico condensa
- (E) raccordo a T femmina (per Extra Line, Melody Line, Forma Iris plus, Iris up, Rose, Top Line, Seven, Simpatty Line, Twin).

- (G) comignolo parapioggia
- (H) doppio bicchiere femmina

## KIT CANALIZZAZIONE ARIA CALDA

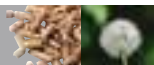

### KIT 8

per Aida, Medea, Kelly, Tiny locale + 1 locale adiacente.

### KIT 10

per Simpatty Line locale + 1 locale adiacente.

### KIT 10 bis

per Simpatty Line locale + 1 locale non adiacente.

### KIT 11

per Top Line locale + 1 locale adiacente.

### KIT 11 bis

per Top Line locale + 1 locale non adiacente.

## KIT 4

ideale per **produzione istantanea** di acqua sanitaria.

Adatto solo per uso moderato per termostufe a pellet con potenza minima pari a 14kW.

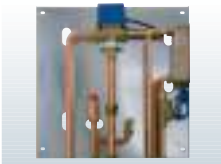

## BOLLITORE

Accessorio per termostufe/caldaie.

- Consente di accumulare acqua calda sanitaria (anche a generatore spento).
- Utile per generatori di bassa potenza (inferiore ai 24kW).
- Con serpentina elettrica può produrre acqua calda sanitaria anche a generatore disattivato (estate).

**CANNE IN ACCIAIO 2 MM - per stufe a legna**  
Scarico naturale verticale Ø 12/13 cm, acciaio verniciato grigio o nero

**IDROKIT**  
legna e pellet

Spezzone canna c/serranda cm 30 con innesto    Spezzone canna c/serranda cm 30 con innesto    Curva con ispezione a 45°    Rosone fisso a parete    Rosone telescopico    Rosone per curva a 45°    Kit anticondensa

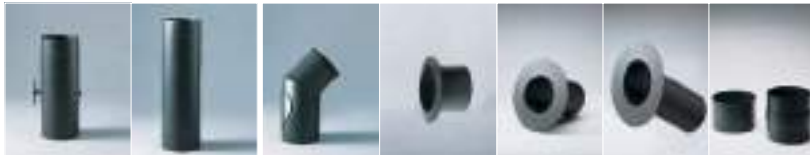

Con Idrokit, è possibile accumulare acqua calda sanitaria nel bollitore da 50 litri in dotazione, e averla sempre disponibile alla temperatura desiderata, anche a termostufa spenta.



**KIT CANALIZZAZIONE ARIA CALDA**

**KIT PER IMPIANTI A VASO CHIUSO**

**n° 1 KIT 8**

per Evolution Line locale + 1 locale adiacente.

**n° 2 KIT 8**

per Evolution Line locale + 2 locali adiacenti.

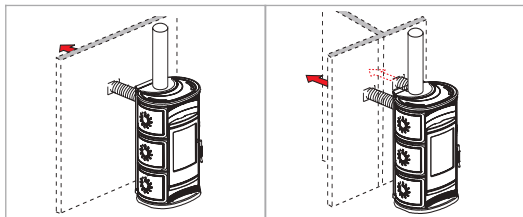

**KIT 5** cm 55 x 14 x 71h

ideoneo per installazione generatore come unica fonte di calore **senza produzione** di acqua sanitaria.  
Con regolatore esterno.

**KIT 6** cm 55 x 14 x 71h

ideoneo per installazione generatore **con produzione** di acqua sanitaria.  
Con regolatore esterno.

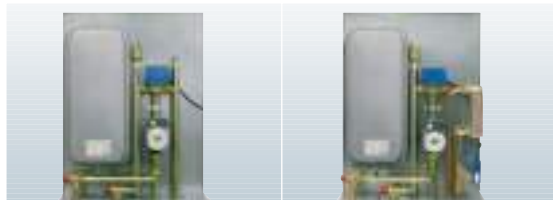

**KIT PER IMPIANTI A VASO APERTO**

**KIT 1**

ideoneo per installazione generatore come unica fonte di calore **con produzione istantanea** di acqua sanitaria.  
Con regolatore esterno.

**KIT 2**

ideoneo per installazione generatore abbinato ad altra caldaia (a gas, gasolio o altro) **senza produzione** di acqua sanitaria.  
Con regolatore esterno.

**KIT 3**

ideoneo per installazione generatore abbinato ad altra caldaia (a gas, gasolio o altro) **con produzione istantanea** di acqua sanitaria.  
Con regolatore esterno.

**KIT N3**

ideoneo per installazione generatore abbinata ad altra caldaia (a gas, gasolio o altro) **con produzione istantanea** di acqua sanitaria.  
Con scambiatore a tre vie e regolatore incorporato.

**KIT N3 bis**

ideoneo per installazione generatore abbinato a caldaia (a gas, gasolio o altro) **con produzione istantanea** di acqua sanitaria, comprensivo di circolatore per circuito secondario.  
Con scambiatore a tre vie e regolatore incorporato.



**ACCESSORI**

**Attrezzi fuoco**

Curvo    Nero    Nichel



**Bidone aspiracenere Glasskamin**  
da usare con aspiratore



**Portalegna Nero**



**Piastra a pavimento**



**Cassette optional**  
per alloggiamento kit



CS 203470 50.07.11/N



**EDILKAMIN**  
TECNOLOGIA DEL FUOCO

[www.edilkamin.com](http://www.edilkamin.com)