

**FOCUS**<sup>®</sup>  
cheminées contemporaines

FILIOFOCUS CENTRAL 1600

**INSTALLATION, SERVICING  
AND USER INSTRUCTIONS**

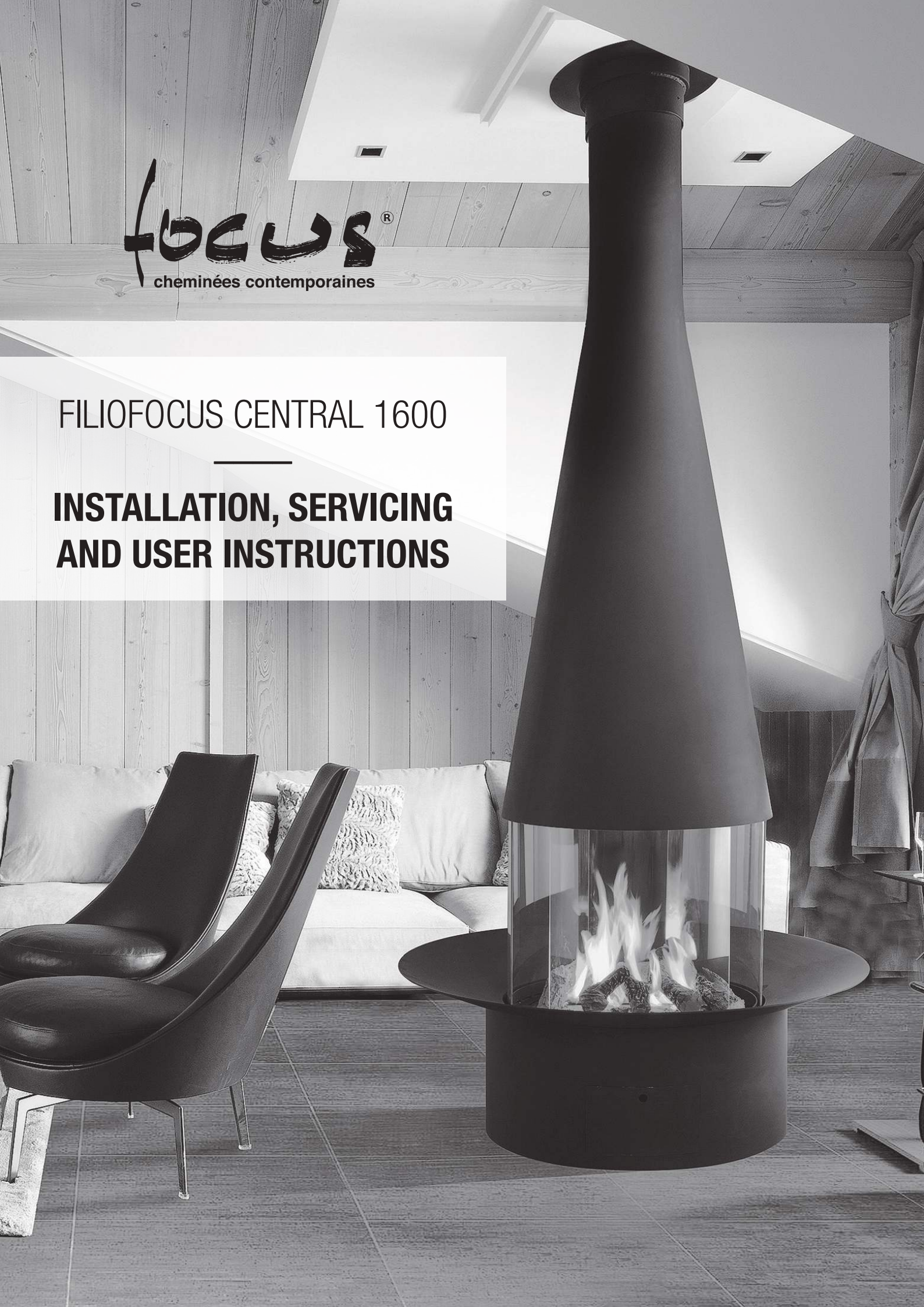

# Contents

## IMPORTANT

This appliance should only be installed and serviced by a qualified engineer (i.e. Corgi registered engineer).

These instructions should be left with the customer for future reference.

GENERAL SECTION.....	03	SERVICING.....	13
■ DIMENSIONS OF FIRE.....	03	■ TROUBLESHOOTING.....	13
■ TECHNICAL INFORMATION.....	03	A. THE GAS PILOT WILL NOT IGNITE	
GENERAL POINTS FOR THE PURCHASER		OR STAY LIT ?	
		B. THE PILOT IS NOT BURNING	
		OR PERFORMING CORRECTLY ?	
		C. THE MAIN BURNER DOES NOT SEEM	
		TO BE BURNING CORRECTLY ?	
USER INSTRUCTIONS.....	04	■ SERVICING INSTRUCTIONS.....	13
■ INFORMATION FOR INSTALLERS.....	04	■ SERVICE PARTS.....	13
■ SITING THE APPLIANCE.....	04		
■ FLUE CONNECTION.....	05		
■ CONNECTING THE GAS SUPPLY.....	05		
■ PRESSURE TESTING.....	05		
■ ARRANGING THE LAYOUT OF THE COALS.....	05		
A. LOG ARRANGEMENT			
B. PEBBLE ARRANGEMENT			
■ TEST FOR SPILLAGE.....	06		
INSTALLATION INSTRUCTIONS.....	07		
■ OPERATING THE FIRE.....	07		
■ OPERATING INSTRUCTIONS.....	07		
A. GENERAL NOTES			
B. SETTING THE ELECTRONIC CODE			
(first time use only)			
C. SETTING FAHRENHEIT OR CELSIUS			
D. SETTING THE TIME			
E. CHILD PROOF			
F. MANUAL MODE (handset)			
G. DESIGNATED LOW FIRE AND HIGH FIRE			
H. COUNTDOWN TIMER			
I. MODES OF OPERATION			
J. THERMOSTATIC MODE			
K. PROGRAM MODE			
L. AUXILIARY FEATURE			
M. ECO MODE			
■ MANUAL TURN OFF.....	12		

# General section

## ■ DIMENSIONS OF FIRE

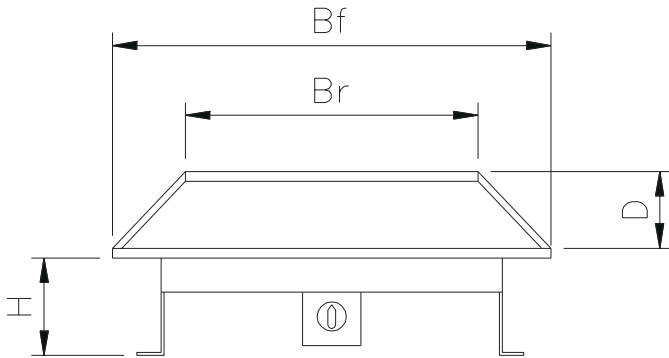

## PHYSICAL DIMENSIONS (mm)

Breadth (front)	Bf	390
Breadth (rear)	Br	390
Depth	D	105
Height	H	Adjustable

## ■ TECHNICAL INFORMATION

**Gas Type:**

- Natural: G20 / I2H
- LPG: G31 / I3P / I3BP

**Gas Input Gross:** See section 2.

**Pipe connection:** 8mm via supplied adapter.

**Manual Option:** Variable rotary gas control with integrated Piezo Ignition, permanent pilot facility and flame failure safety device.

**Remote option:** Variable rotary gas control with integrated Piezo Ignition, permanent pilot facility and flame failure safety device, with appliance mounted eye for remote control via handset. No external power supply required.

**Flue Requirements:** Class I.

MODEL	H24	
	Natural G20 / I2H	LPG G31 / I3P / I3BP
Heat Input, Gross (kW)	9	7,8
Supply Pressure (mbar)	20	37 - 30
Burner Pressure (mbar)	14	36 - 28
Gas Rate (m3/h)	0,89	0,31
Injector Marking	650	220

## GENERAL POINTS FOR THE PURCHASER

**This appliance is intended for decorative purposes only.**

The Fire is designed to run off either Natural or LPG gas. It is important to note that once a type of gas has been specified the Fire cannot run off any other type. The type of gas that your Fire is capable of burning is stated on the data information panel, located on the under side of the burner.

This burner has an Oxygen Depletion System (ODS), the system is not adjustable, and should not be rendered in operative. The ODS will stop the supply of gas if the evacuation of flue gasses is interrupted. If this occurs then a 10 minute period should be allowed before reignition is attempted as described in section 10.1. If this situation recurs then a specialist should be informed.

If parts of the fire requires replacement only original parts must be used. These are available through the dealer from whom you purchased the Fire.

## IMPORTANT

Before installing the fire check that the data plate indicates the suitability of the type of gas being used. I.e. Natural gas pressure.

# User instructions

## ■ INFORMATION FOR INSTALLERS

The burner is designed to run on Natural or LPG gas. The burner unit is not interchangeable between gas types.

The fire is an open radiant log effect appliance which can be placed directly inside any fireplace opening of the dimensions stated within the installation instructions.

### IMPORTANT

**Ventilation** : any air vent shall be fitted in accordance with national regulations.

These instructions have been compiled in accordance with EN 509.

Ensure that the appliance corresponds to the type of gas it is to be used with. This can be confirmed by checking the data badge located on the appliance.

It is required that any appliance using gas is installed by a competent person, in conjunction with the instructions and the requirements as laid down in the relevant Regulations.

The installation must be in accordance with the Gas Safety Installation and Use Regulations 1984 and with these instructions, and all the relevant parts of the Local and National Building Regulations, and the recommendations of the relevant Codes of Practice.

- The Gas safety (Installation and Use) Regulations
- The Building Regulations
- The Building Standards (Scotland) (Consolidation) Regulations.

### IMPORTANT

Appliance to be installed in accordance to national regulations.

All surfaces except the control knob, and lower front door opening knob are considered to be working surfaces.

### IMPORTANT

Protection for young children or the infirm is not given by this appliance, and as such a suitable fireguard should be used in these conditions.

## ■ SITING THE APPLIANCE

DIAMETRE: 180-250 mm

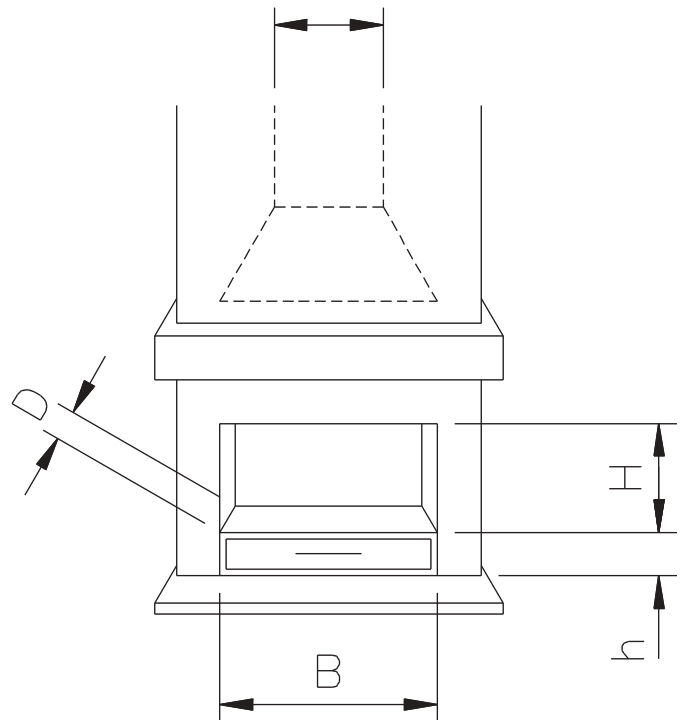

### ▲ WARNING

Dimensions B, D, H and h Determined by the user and it is the Installer responsibility to make sure a smoke test is carried out to prevent spillage.

The gas connection requires semi rigid pipe (8mm with fitting adaptor to 1/2" BSP), not more than 1 metre in length, is recommended.

The appliance can be installed in any adequate area suitable for solid fuel fires and Fires.

The appliance must be located at least 250mm from any combustible materials.

## HEARTH

The appliance must stand on a fireproof hearth.

To comply with the Building Regulations issued by the Department of the Environment, the following points should be noted when choosing a hearth:

1. The hearth must be made of non-combustible material of thickness 50mm minimum.
2. The hearth must protrude at least 300mm in front of the Fire and 150mm each side.

# User instructions

## ■ FLUE CONNECTION

Before installation of the appliance the chimney or flue must be inspected by a competent person and passed as suitable. A smoke test should be carried out before the installation of the Fire.

This appliance is suitable for Class 1 flues (the Building Regulations 1984).

It is the responsibility of the installer to ensure that the flue is suitable for the conditions experienced when burning gas.

The minimum effective height of the flue must be 5 metres measured from the hearth to the Terminal of the flue. If the flue has any non-vertical sections the height should be increased. Prior to installation the installer should ensure that the flue is free from obstruction and ideally a chimney should be swept and subsequently smoke tested. Ensure that any dampers are fixed in a permanently open position.

## ■ CONNECTING THE GAS SUPPLY

Ensure that the gas supply pipework is capable of delivering the required volume of gas in accordance with the relevant Standards.

A gas soundness test must be carried out before operating the Fire.

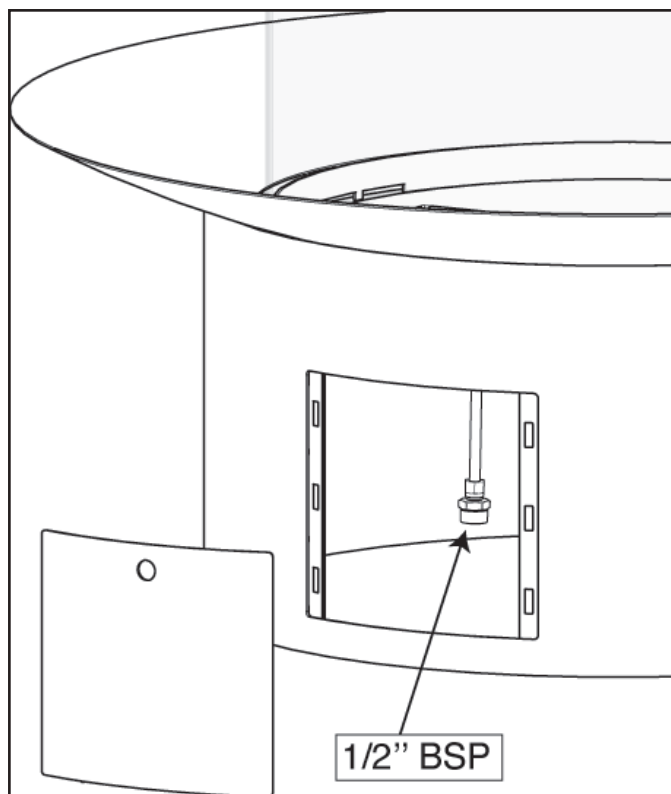

## ■ PRESSURE TESTING

The gas pressure to the burner must be measured at the burner test nipple. Burner Pressures required are given in the table in section 2 Technical Information of this manual. A tolerance of +/-5% may be applied to these burner pressures.

## ■ ARRANGING THE LAYOUT OF THE COALS

Only the ceramics supplied with this appliance are to be used. The logs should only be laid as shown on the following pages. Replacements are available from your dealer, but should be installed by a competent person.

### IMPORTANT

Please ensure that when fitting the ceramics, that you **do not obstruct the pilot.**

Focus accept no responsibility for any injury sustained whilst handling hot ceramics.

### A. LOG ARRANGEMENT

Parts – 6 ceramic logs, 1 bag of embers.



Lay the logs as shown in the diagrams below. Start by placing the Large log in the centre of the Burner Top. Locating the log centrally and symmetrical with the holes in the Top Plate.

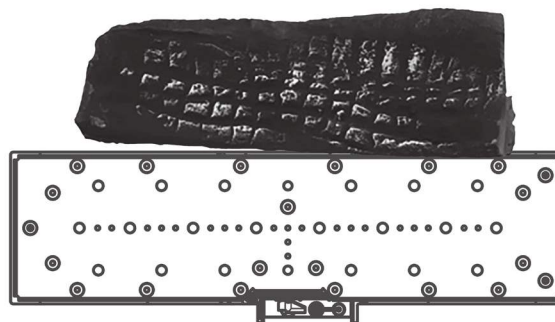

# User instructions

Next place the Split small log leaning on the larger log, as shown in the photo below.

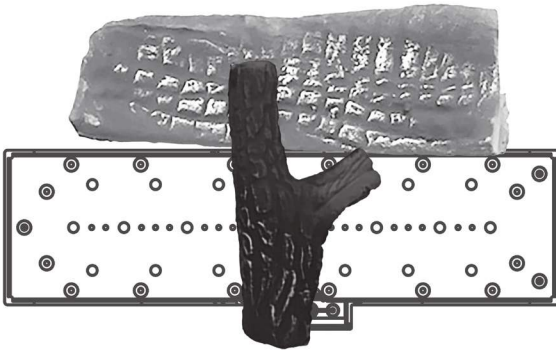

Next place the three small logs around the larger log, as shown in the photo below.

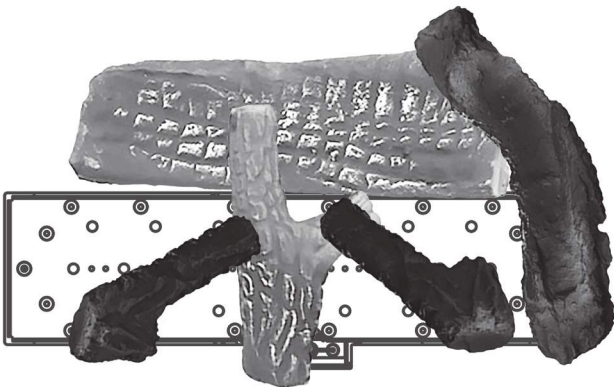

Next place the Medium log on the left around the larger log, as shown in the photo below.

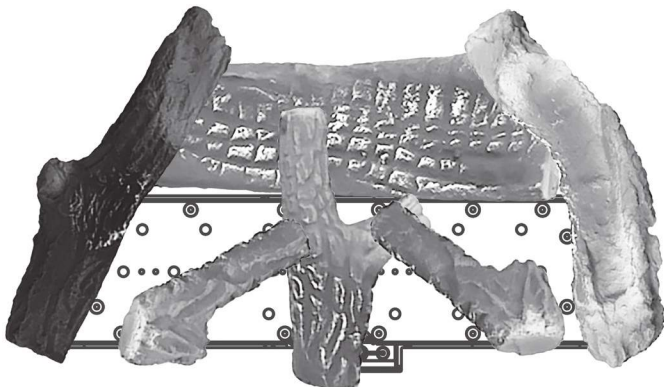

Finally open the bag of Embers and scatter it over the top of the burner between the logs.

## B. PEBBLE ARRANGEMENT

Parts – 22 ceramic pebbles.

Place the Ceramic Mat on the Burner Top, aligning the holes with those on top of the burner. Place 5 pebbles along the rear of the burner (1 to 5). Place another row of 5 pebbles in front of these (6 to 10). Now place 3 pebbles in front of the centre (11 to 13), 3 pebbles of the previous row. Next, place 3 pebbles to the R/H side of the Pilot shield and forward of the previous 3 pebbles (14 to 16). Place 1 pebble in both of the front corners of the burner (17 to 18). The remaining 4 pebbles are nested on top of the 2nd and 3rd row of pebbles (19 to 22). This can all be seen in the figure below.

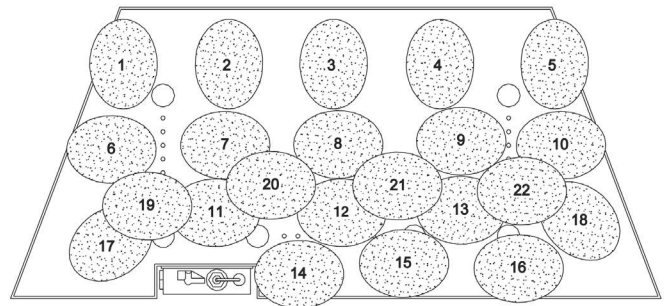

## ■ TEST FOR SPILLAGE

### IMPORTANT

A spillage test **MUST** be made before the installed Fire is left with the customer.

Carry out the test by first closing all doors and windows in the room containing the Fire.

Ensure that the Fire is burning at full rate for a minimum of 5 minutes.

With the appliance still lit apply a smoke match or smoke puffer into the flue or gas fire canopy, and ensure that all smoke is drawn into the flue.

If there is a fan in a nearby room the spillage test must be repeated with the fan running and all connecting doors between the fire and fan left open.

If there are still problems the chimney/flue may require attention. Disconnect the Fire and seek expert advice.

# Installation instructions

## ■ OPERATING THE FIRE

### IMPORTANT

It is very important to read these instructions thoroughly before lighting the fire.

Please explain to the customer these lighting and extinguishing procedures, and ensure that the user is warned not to disturb the fuel bed, or contaminate it with any other items.

This appliance operates with a traditional permanent pilot light.

The pilot light is located at the rear left of the burner and is visible past the logs.

If the Flame Supervision Device Actuating Flame (the pilot light) is extinguished either intentionally or not, no attempt should be made to relight until 10 minutes have elapsed.

### IMPORTANT

Immediately after lighting, the Fire must be left on maximum setting for 10 minutes in order to warm up the chimney.

## ■ OPERATING INSTRUCTIONS

### A. GENERAL NOTES

#### NOTICE

Wiring of valve and receiver must be completed before starting ignition. Failure to do so could damage the electronics.

#### Batteries – Handset

- Low battery indicator on handsets.

#### Batteries – Receiver

- Low battery indication: frequent beeps for 3 seconds when motor turns.
- An AC mains adapter may be used instead of batteries.
- The module for fan speed control and light/dimmer includes mains power together with batteries in the receiver for automatic backup in case of power outage.

#### ▲ WARNING

- Without using a mains adapter, battery replacement is recommended at the beginning of each heating season.
- Old or dead batteries should be removed immediately. If left in the unit the batteries can overheat, leak, and / or explode.
- Do NOT expose batteries (including during storage) to direct sunlight, excessive heat, fire, moisture, or severe impact. Each of these conditions can cause the batteries to overheat, leak, and / or explode.
- Batteries must be kept within their recommended temperature limits. (Ambient battery temperature range: 32 °F to 131 °F [0 °C to 55 °C].)
- New and old batteries and different brands of batteries should not be used together. Mixing of various batteries can cause the batteries to overheat, leak, and / or explode.

#### Software Version

Press  and  buttons simultaneously. Software version is displayed.

#### Handset Model Number

Press  and  buttons simultaneously. Handset model number is displayed.

#### Deactivate Functions

1. Install batteries. All icons are displayed and flashing.
2. While the icons are flashing, press the relevant function button and hold for 10 sec.
3. The function icon will flash until deactivation is complete. Deactivation is complete when the function icon and two horizontal bars are displayed.

**NOTE:** If a deactivated button is pressed, there is no function, and two horizontal bars are displayed.

**NOTE:** Deactivation remains in effect after change of batteries.

#### Activate Functions

1. Install batteries. All icons are displayed and flashing.
2. To activate a function, press the relevant button and hold for 10 sec.
3. The function icon will continue to flash until activation is complete. Activation is complete when the function icon is displayed.

#### The following Functions can be Deactivated / Activated

- CHILD PROOF
- PROGRAM MODE
- THERMOSTATIC MODE (also deactivates PROGRAM MODE)
- ECO MODE
- LIGHT / DIMMER OPERATION
- CIRCULATING FAN OPERATION
- AUXILIARY FEATURE
- COUNTDOWN TIMER

### B. SETTING THE ELECTRONIC CODE (First time use only)

#### Radio Frequency Handset

A code is selected automatically for all Mertik Maxitrol electronics from among 65,000 codes available. The receiver must be paired with the handset.

The receiver has to learn the handset code:

Press and hold the receiver's reset button until you hear two (2) beeps. After the second, longer beep, release the reset button. Within the subsequent 20 seconds press the  button on the handset until you hear two (2) short beeps confirming the code is set.

**NOTE:** This is a one time setting only, and it is not required when changing the batteries in the handset or receiver.

# User instructions

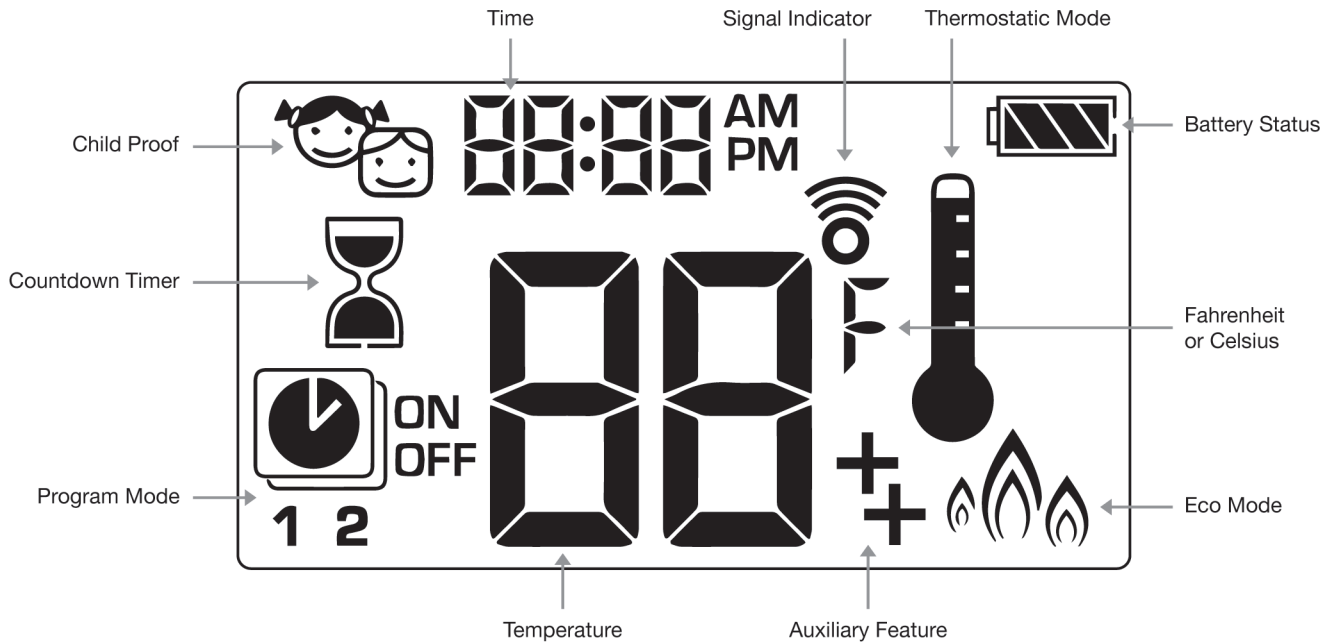

Figure 01: 8-symbol Display

## C. SETTING FAHRENHEIT OR CELSIUS



To change between °C and °F, press and buttons simultaneously.

**NOTE:** Choosing °F results in a 12 hour clock. Choosing °C results in a 24 hour clock.

## E. CHILD PROOF

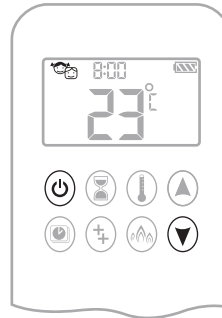

**ON:**  
To activate press and buttons simultaneously. displayed and the handset is rendered inoperable, except for the off function.

**OFF:**  
To deactivate press and buttons simultaneously. disappears.

## D. SETTING THE TIME



1. Press and buttons simultaneously. Day flashes.
2. Press or button to select a number to correspond with the day of the week (e. g. 1 = Monday, 2 = Tuesday, 3 = Wednesday, 4 = Thursday, 5 = Friday, 6 = Saturday, 7 = Sunday).
3. Press and buttons simultaneously. Hour flashes.
4. To select hour press or button.
5. Press and buttons simultaneously. Minutes flash.
6. To select minutes press or button.
7. To confirm press and buttons simultaneously or wait.

## F. MANUAL MODE (handset)

### NOTICE

#### BEFORE OPERATING

- 1 Make sure MANUAL knob on the GV60 valve is in the **ON**, full counterclockwise position.
2. Place the ON/OFF switch (if equipped) in the **I** (ON) position.

#### TO TURN ON FIRE

### ▲ WARNING

When pilot ignition is confirmed, motor turns automatically to maximum flame height.



# User instructions

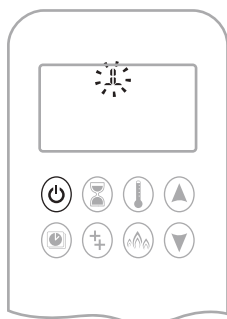

## Handset One-Button Operation (Default Setting)

- Press until two short beeps and a blinking series of lines confirms the start sequence has begun; release button.
- Main gas flows once pilot ignition is confirmed.
- Handset automatically goes into Manual Mode after main burner ignition.

### NOTICE

Change from one-button to two-button ignition operation by pressing and holding for 10 sec. immediately after installing batteries. **ON** is displayed and **1** is flashing. When change is complete **1** will change to **2**.



## Handset Two-Button Operation

- Press and simultaneously until two short beeps and a blinking series of lines confirms the start sequence has begun; release buttons.
- Main gas flows once pilot ignition is confirmed.
- Handset automatically goes into Manual Mode after main burner ignition.

### NOTICE

Change from two-button to one-button ignition operation by pressing and holding for 10 sec. immediately after installing batteries. **ON** is displayed and **2** is flashing. When change is complete **2** will change to **1**.

### ▲ WARNING

If the pilot does not stay lit after several tries, turn the main valve knob to **OFF** (p. XX).

## STANDBY MODE (PILOT FLAME)

### Handset

- Press and hold to set appliance to pilot flame.

## TO TURN OFF FIRE



### Handset

- Press to turn OFF.

**NOTE:** A new ignition is possible after the OFF icon stops flashing.

## FLAME HEIGHT ADJUSTMENT

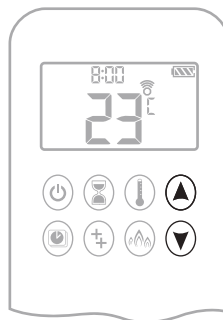

### Handset

- To increase flame height press and hold button.
- To decrease flame height or to set appliance to pilot flame, press and hold button.

## G. DESIGNATED LOW FIRE AND HIGH FIRE

**NOTE:** Backlight must be on for high fire and low fire double-click operation.

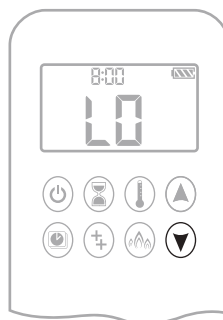

- To go to low fire, double-click button. **L0** is displayed.

**NOTE:** Flame goes to high fire first before going to low fire.



- To go to high fire, double-click button. **H1** is displayed.

### ▲ WARNING

If the appliance will not operate, turn the main valve knob to **OFF** (p. XX).

# User instructions

## H. COUNTDOWN TIMER

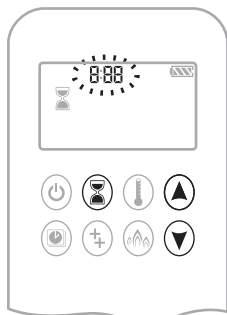

### ON/SETTING:

1. Press and hold button until displayed, and hour flashes.
2. To select hour press or button.
3. To confirm press button. Minutes flash.
4. To select minutes press or button.
5. To confirm press button or wait.

### OFF:

Press button, and countdown time disappear.

**NOTE:** At end of countdown time period, the fire shuts off. The Countdown Timer only works in Manual, Thermostatic, and Eco Modes. Maximum countdown time is 9 hours and 50 minutes.

## I. MODES OF OPERATION



### Thermostatic Mode

The room temperature is measured and compared to the set temperature. The flame height is then automatically adjusted to achieve the set temperature.



### Program Mode

PROGRAMS 1 and 2, each can be programmed to go on and off at specific times at a set temperature.



### Eco Mode

Flame height modulates between high and low. If the room temperature is lower than the set temperature, the flame height stays on high for a longer period of time. If the room temperature is higher than the set temperature, the flame height stays on low for a longer period of time. One cycle lasts approx. 20 min.

## J. THERMOSTATIC MODE



### ON:

Press button. displayed, preset temperature displayed briefly, and then room temperature displayed.

### OFF:

1. Press button.
2. Press or button to enter Manual Mode.
3. Press button to enter Program Mode.
4. Press button to enter Eco Mode.

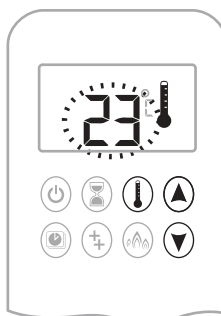

### SETTING:

1. Press button and hold until displayed, temperature flashes.
2. To adjust set temperature press or button.
3. To confirm press button or wait.

## K. PROGRAM MODE

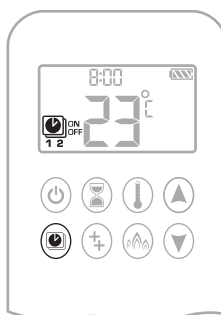

### ON:

Press button. , **1** or **2**, **ON** or **OFF** displayed.

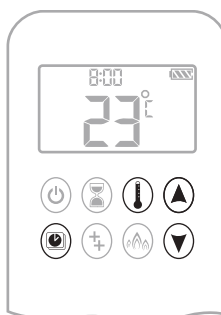

### OFF:

1. Press or or button to enter Manual Mode.
2. Press button to enter Thermostatic Mode.

**NOTE:** The set temperature for Thermostatic Mode is the temperature for the on time in Program Mode. Changing the Thermostatic Mode set temperature also changes the on time temperature in Program Mode.

# User instructions

## Default settings:

ON TIME (Thermostatic) TEMPERATURE: 21 °C (70 °F)  
OFF TIME TEMPERATURE: “--” (pilot flame only)

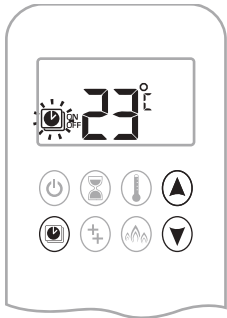

### TEMPERATURE SETTING:

1. Press button and hold until flashes. **ON** and set temperature (setting in Thermostatic Mode) displayed.
2. To continue press button or wait. , **OFF** displayed, temperature flashes.
3. Select off temperature by pressing the or button.
4. To confirm press button.

**NOTE:** The on (Thermostatic) and off set temperatures are the same for each day.



### DAY SETTING:

5. **ALL** flashes. Press or button to choose between **ALL**, **SRSU**, 1, 2, 3, 4, 5, 6, 7.
6. To confirm press button.

## ALL selected

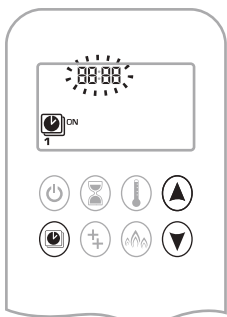

### ON TIME SETTING (PROGRAM 1):

7. , **1**, **ON** displayed, **ALL** is displayed shortly, and **hour** flashes.
8. To select hour press or button.
9. To confirm press button. , **1**, **ON** displayed, **ALL** displayed shortly, and **minutes** flash.
10. To select minutes press or button.
11. To confirm press button.

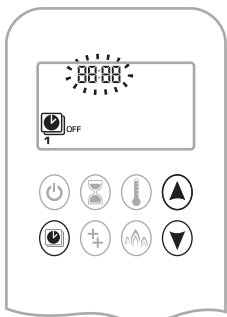

### OFF TIME SETTING (PROGRAM 1):

12. , **1**, **OFF** displayed, **ALL** is displayed shortly, and **hour** flashes.
13. To select hour, press or button.
14. To confirm press button. , **1**, **OFF** displayed, **ALL** displayed shortly, and **minutes** flash.
15. To select minutes press or button.
16. To confirm press button.

**NOTE:** Either continue to PROGRAM 2 and set on and off times or stop programming at this point, and PROGRAM 2 remains deactivated.

**NOTE:** PROGRAM 1 and 2 use the same on (Thermostatic) and off temperatures for **ALL**, **SRSU** and Daily Timer (1, 2, 3, 4, 5, 6, 7). Once a new on (Thermostatic) and / or off temperature has been set, that temperature becomes the new default setting.

**NOTE:** If **ALL**, **SRSU** or Daily Timer are programmed for PROGRAM 1 and PROGRAM 2 on and off times, these become the new default times. The batteries must be removed to clear the PROGRAM 1 and PROGRAM 2 on and off times and temperatures.

## SRSU or Daily Timer (1, 2, 3, 4, 5, 6, 7) selected

- Set on time and off time using same procedure as “**ALL** selected” (above).
- **SRSU**: Set on time and off time for both Saturday and Sunday.
- Daily Timer: Unique on and off times may be set for a single day of the week, for multiple days of the week, or for every day of the week.
- Wait to finish setting.

## L. AUXILIARY FEATURE

Upon ignition burner 1 is on and burner 2 is in the last setting.

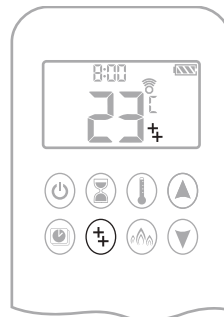

### ON:

To switch a burner **ON**, press the button. displayed.

### OFF:

To switch the burner **OFF**, press the button. disappears.

**NOTE:** The latching solenoid valve cannot operate manually. If the receiver battery runs down it will remain in the last operating position.

## M. ECO MODE

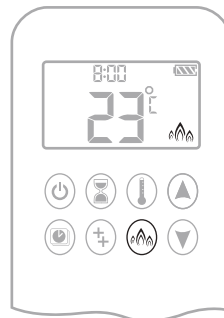

### ON:

Press button to enter Eco Mode. displayed.

### OFF:

Press button. disappears.

# User instructions

## ■ MANUAL TURN OFF

In the event that the appliance needs to be turned OFF manually, for instance, if the remote control is lost or the batteries become totally flat, the control valve must be accessed and the switch flipped to OFF (marked "0").

The picture below shows the control valve.

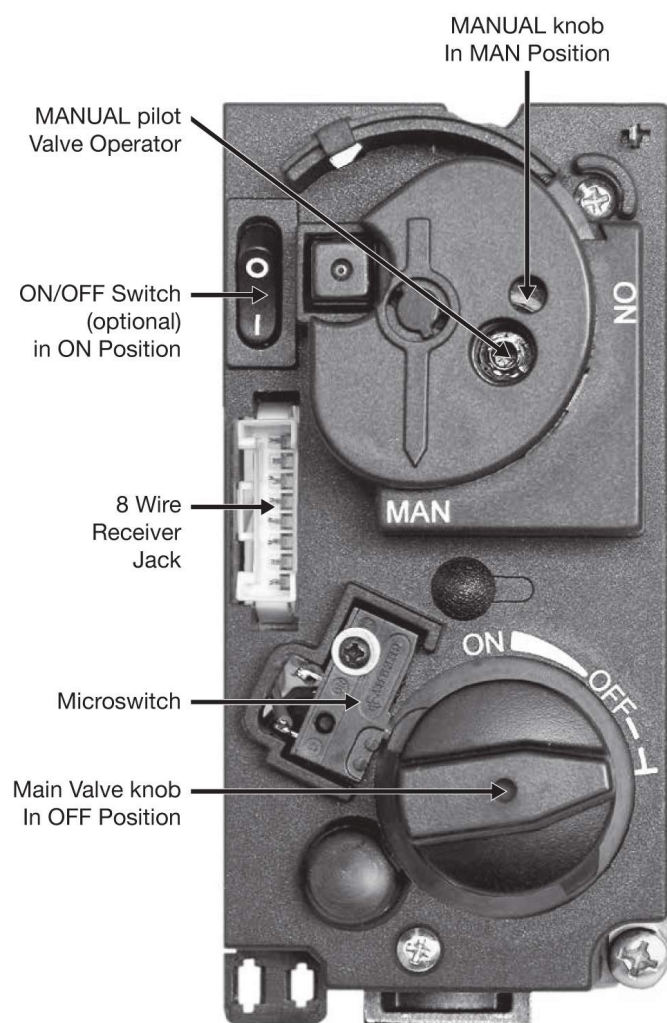

# Servicing

## IMPORTANT

Any intervention on the appliance must be carried out by a gas approved technician.

## ■ TROUBLESHOOTING

### A. THE GAS PILOT WILL NOT IGNITE OR STAY LIT ?

- Ensure the gas is turned on at the appliance and the meter/cylinder.
- Hold in the pilot gas button for at least 20 seconds once the pilot is alight to ensure the operation of the safety Thermocouple valve.
- Ensure that the pilot injector is not obstructed or blocked and is free from any dust or dirt.
- Ensure that the Thermocouple has not been damaged in transit. This is a very delicate Electro-magnetic device

### B. THE PILOT IS NOT BURNING OR PERFORMING CORRECTLY ?

- Ensure the pilot flame is the correct size for the type of gas. The flame should be focused on the thermocouple probe, so that it is evenly encircled.
- The pilot should have two flames, one directed towards the thermocouple, and one towards the bed of the fire. The pilot head will have been set correctly in the factory.

### C. THE MAIN BURNER DOES NOT SEEM TO BE BURNING CORRECTLY ?

- Ensure adequate gas pressure to the appliance. The pressure can be measured by unscrewing the pressure test nipple on the tap and applying a suitable pressure gauge (i.e. a manometer). Ensure adequate volume of gas is being used. Once the fire is burning on maximum, turn off all other gas appliances in the house and calculate the fuel being burned from the gas meter.
- Make sure that the burner is burning correctly. The flames should be fairly even across the top of the burner before any logs, pebbles or embers are placed on top.

## ■ SERVICING INSTRUCTIONS

This appliance should be serviced annually.

These instructions are meant to be used in conjunction with the normal servicing practices that a Corgi authorised installer would use.

1. Remove the Logs and embers carefully and replace any that are damaged or broken.
2. Clean any deposition of lint off the burner. This can be done with a soft brush, or vacuum cleaner.
3. Inspect the burner unit.
4. Relay the Fire in line with the instructions "arranging the layout of the Logs".
5. There should be no need to service the burner. If however this is required, a competent fitter should check the setting pressure at the nozzle on the gas inlet of the burner. The correct pressure required is stated on the data information plate.

During servicing the chimney should be checked to ensure that products of combustion are entering the flue, and that there is no excessive build up of soot. Any soot deposits will require removal. Any purpose provided ventilation should be free from obstruction.

## ■ SERVICE PARTS

Only the logs, embers, pebbles and gas tap/valve are serviceable. Only spares of the correct type should be used.

# Note

A series of horizontal dotted lines for writing notes.

# Note

A series of horizontal dotted lines for writing notes.



Création - Édition - Distribution :  
Atelier dominique imbert

S.A.S. au capital de 102 355 euros  
34380 Viols-le-Fort  
France

Tel. : 00 33 (0)4 67 55 01 93  
Fax. : 00 33 (0)4 67 55 77 77  
Web : [www.focus-creation.com](http://www.focus-creation.com)  
Email : [info@focus-creation.com](mailto:info@focus-creation.com)