

# Pellet stoves

**Please read this entire manual before installation and use of this pellet fuel-burning room heater. Failure to follow these instructions could result in property damage, bodily injury or even death.**

**Contact local building or fire officials about restrictions and installation inspection requirements in your area.**

**Contact local building authority (such as municipal building department, fire department, fire prevention, bureau. etc.) before installation to determine if a permit and/or inspection is required.**

**Save these Instructions.**

**OPERATING INSTRUCTIONS  
FIRMWARE FWDA00 - H09901290**

 **PIAZZETTA**

## OPERATING INSTRUCTIONS

Dear Customer,

We thank you for having chosen one of our products, the fruit of extensive and continuous research for a superior product in terms of safety, reliability and performance.

In the documentation supplied, you will find all the information and advice you need to use your product as safely and efficiently as possible.

-  Read the instructions and the information, supplied in all forms together with the product and any accessories, as well as the documentation referred to in this manual carefully, before proceeding with installation, use or any repairs.
- If any problems or doubts should arise, please contact your local dealer or the authorized T.A.C. (authorized technical assistance centre).

-  This manual contains INFORMATION REGARDING APPLIANCE OPERATION.
- Please refer to the manual for further information "*PRODUCT INFORMATION, INSTALLATION AND MAINTENANCE*".

For the restrictions, limitations and exclusions please refer to the warranty included with the product. In line with its policy of constant product improvement and renewal, the manufacturer may make changes without notice.

**The images shown in this manual are for explanatory purposes and at times may not accurately depict the product.**

**This document is the property of Gruppo Piazzetta S.p.A. and no part of it may be reproduced or disclosed to third parties, wholly or in part, without written permission All rights reserved by Gruppo Piazzetta S.p.A..**

## CONTENTS

<b>1</b>	<b>GENERAL INFORMATION</b>	<b>4</b>		
<b>2</b>	<b>FUEL</b>	<b>6</b>		
<b>3</b>	<b>REMOTE CONTROL</b>	<b>7</b>		
3.1	Remote control functions	7		
3.2	Changing the batteries of the remote control unit	7		
<b>4</b>	<b>APPLIANCE CONTROL PANEL</b>	<b>7</b>		
4.1	6 key control panel functions	7		
4.2	Setting the language	8		
<b>5</b>	<b>BEFORE STARTING-UP THE APPLIANCE</b>	<b>8</b>		
5.1	Information regarding the first start-up	8		
5.2	Check network voltage and frequency	9		
5.3	Fill auger	9		
<b>6</b>	<b>STARTING THE APPLIANCE</b>	<b>9</b>		
<b>7</b>	<b>CHANGE THE POWER</b>	<b>10</b>		
<b>8</b>	<b>CHANGE ROOM TEMPERATURE</b>	<b>10</b>		
<b>9</b>	<b>CHANGE THE VENTILATION</b>	<b>10</b>		
<b>10</b>	<b>SHUTTING-DOWN THE APPLIANCE</b>	<b>10</b>		
<b>11</b>	<b>PARTICULAR SITUATIONS</b>	<b>10</b>		
11.1	Restarting during the shut down phase	10		
11.2	Shut down during the start-up phase	11		
11.3	Safety warnings: how to act	11		
11.4	Operation in adverse climatic conditions	11		
<b>12</b>	<b>MENU</b>	<b>12</b>		
12.1	Main MENU functions	12		
12.2	Access menu keys	13		
<b>13</b>	<b>SET DATE AND TIME (CLOCK)</b>	<b>13</b>		
13.1	Unit of measurement	13		
<b>14</b>	<b>PROGRAMME CHRONO (CHRONO)</b>	<b>13</b>		
<b>15</b>	<b>ENERGY SAVING</b>	<b>15</b>		
<b>16</b>	<b>NIGHT MODE</b>	<b>16</b>		
<b>17</b>	<b>ENABLE ACOUSTIC SIGNAL (BEEP)</b>	<b>16</b>		
<b>18</b>	<b>INSTALLER</b>	<b>17</b>		
18.1	N.PEL contact	17		
18.2	Operation with an external thermostat	17		
18.3	Memory counters	18		
18.4	Display	18		
18.5	Settings (Tech Menu)	19		
<b>19</b>	<b>STOVE STATUS</b>	<b>19</b>		
<b>20</b>	<b>MESSAGES - SAFETY WARNINGS - ANOMALIES</b>	<b>19</b>		
20.1	<b>Messages</b>	<b>19</b>		
	Message "CLEANING GRATE"	19		
	Message "EMPTY GRATE"	19		
	Message "SERVICE TIME"	19		
	Message "EXT THERM OK"	20		
	Message "OFF T"	20		
	Message "OFF E"	20		
	Message "OFF N"	20		
	Message "P1 N"	20		
	Message "ENERGY OK"	20		
	Message "ENS"	20		
	Message "WAIT FOR OFF"	20		
	Message "RESTART POWER FAILURE"	20		
	Message "NOT ALLOWED"	20		
	Message "LOCKED KEYBOARD"	20		
	Message "CLOSE"	20		
20.2	<b>Safety warnings</b>	<b>21</b>		
	Warning "E1"	21		
	Warning "E2"	22		
	Warning "E3"	22		
	Warning "E4"	22		
	Warning "E6"	22		
	Warning "E7"	23		
	Warning "E8"	23		
	Warning "E9"	23		
	Warning "E10"	23		
	Warning "E12"	24		
	Warning "E13"	24		
	Warning "E14"	24		
	Warning "E19"	24		
<b>20.3</b>	<b>Other anomalies</b>	<b>24</b>		
	Occasional failure to start-up	24		
	The control panel does not switch on	25		
	The stove runs for 10 minutes then shuts down	25		
	Power supply failure (power failure)	25		
	One item in the menu cannot be accessed	25		

## 1 GENERAL INFORMATION

**Definition:** The term **system** indicates the unit consisting of the appliance and all the necessary installations which affect its operation, including air intakes, the entire system for the evacuation of the flue gases (connecting flue pipe, flue, chimney terminal) the area, other sources of heat, installations for the propagation of heat (hot air ducting or plumbing system).

**Definition:** The term **standards** or **regulations** indicates all applicable national legislation, local regulations, particular or conventional requirements arising from joint ownership building regulations, and easement or laws or administrative acts, in force in the place where the appliance is to be installed.

- This instruction booklet has been prepared by the manufacturer and is an integral part of the product. In the event of sale or relocation of the product make sure this booklet accompanies it, since the information contained in it is addressed to the purchaser and to anyone involved in the installation, use and maintenance of the product.
- Read the instructions and the information, supplied in all forms together with the product and any accessories, as well as the documentation referred to in this manual carefully, before proceeding with installation, use or any repairs. If any problems or doubts should arise, please contact your local dealer or the authorized T.A.C. (authorized technical assistance centre).
- Gruppo Piazzetta S.p.A. cannot be held liable for situations of risk, defects, damage, product malfunctioning or for damage to objects, people or animals resulting from tampering of the appliance and installation, use and maintenance which does not respect the indications provided by regulations and the manufacturer.
- Any changes to the original parameters which determine product operation may only be carried out by authorised persons from the company and with the values set by the manufacturer. Non-authorized interventions on the product will be considered tampering.

 In the event of a malfunction or fault, before carrying out any intervention and before discontinuing product use, please refer to the manual provided by the manufacturer in the sections "FAULTS" or "MESSAGES - SAFETY WARNINGS - ANOMALIES".

 In the event of fire in the flue, stop using the appliance, do not open the door of the appliance, observe all safety recommendations and contact the appropriate authorities.

- For appliances which are powered electrically, do not disconnect the power supply if unburned smoke/gas forms inside the firebox. Move away and adopt all necessary safety precautions.

 Smoke coming from a blocked flue is dangerous. Keep the flue and connecting flue pipe clean. Follow the manufacturer's cleaning instructions.

- Keep the exchangers and smoke passages on the boiler clean. Follow the manufacturer's cleaning instructions.
- Only use the recommended fuel.
- Please read and comply with the instructions for installation, use and maintenance.

 Product use may cause some surfaces to become extremely hot (the glass, the external surfaces, the handles, the smoke outlet passage). Any contact between clothing or body parts and these surfaces, including where accidental, may cause burns or fires.

- Before performing work on parts of the appliance that may be hot (e.g. top surface panel, grilles, covers, door, settings devices and control devices), take the necessary precautions and use suitable protective devices (glove, fire door opening tool or other specific devices).
- Since the glass becomes hot, make sure that no person other than those experienced in operating the appliance remain in the area from where the heat emanates.

 All local regulations, including those referring to national standards need to be complied with when installing the appliance and when operating the appliance.

- Product installation, use and maintenance must be carried out in compliance with the applicable instructions provided by the manufacturer and in compliance with all relevant regulations. Failure to respect the indications provided and any incorrect interventions may create dangerous situations, cause damage to people, property or animals, or lead to health problems or operating faults.

 Product installation and maintenance must be carried out exclusively by qualified personnel with sufficient knowledge of the product itself.

- Only use original spare parts as recommended by the manufacturer.

 Everyone (both children and adults) should be informed of the risk of coming into contact with hot surfaces.

- Babies, young children, animals or anyone else may experience burns as a result of accidental contact. If there are any at-risk subjects in the home, a protective barrier should be installed. To limit access to the appliance, install a safety gate to keep babies, young children and other at-risk subjects out of the room and away from the hot surfaces.

 This appliance is not for use by persons (including children) with reduced physical, sensory, mental capacity or with a lack of experience and knowledge, unless they are helped or have been instructed on how to use the appliance by the person who is responsible for their safety.

- Children shall not play with the appliance. Cleaning and user maintenance shall not be made by children.
- Young children should be carefully supervised when they are in the same room as the stove.

 If you expect that small children or vulnerable adults may come into contact with this appliance, the following precautions are recommended:

- Install a physical barrier such as a decorative firescreen or an adjustable safety gate.
- Install a switchlock or a wall/remote control with child protection lockout feature.
- Keep remote controls out of reach of children.
- Never leave children alone near a hot stove, whether operating or cooling down.
- Teach children to NEVER touch the stove.
- Consider not using the stove when children will be present.

 During the operation and/or cooling phase, slight creaking noises may be heard. This is not considered a defect, but is a consequence of the thermal expansion of the materials used.

 Do not install the product too close to neighbors or in valleys that would cause unhealthy air quality or nuisance conditions.

 It is forbidden any unauthorized modification of the appliance.

 Do not stand or place objects which are not heat-resistant within the prescribed minimum safety distance.

- This also applies when the appliance is off. The appliance may be turned on by somebody else or, where the appliance is pre-configured, may be automatically switched on (programmed or via remote control), at any time.

 Do not install the product near walls or objects in heat-sensitive or combustible material (wood or similar). It is important to observe and respect the distances and safety indications prescribed by regulations and indicated in the manual provided by the manufacturer in the section "*INSTALLATION*".

- IT IS FORBIDDEN TO USE THE APPLIANCE WITHOUT SUITABLE CLADDING.

 THIS WOOD HEATER NEEDS PERIODIC INSPECTION AND REPAIR FOR PROPER OPERATION. IT IS AGAINST FEDERAL REGULATIONS TO OPERATE THIS WOOD HEATER IN A MANNER INCONSISTENT WITH OPERATING INSTRUCTIONS IN THIS MANUAL.

 THIS WOOD HEATER HAS A MANUFACTURER-SET MINIMUM LOW BURN RATE THAT MUST NOT BE ALTERED. IT IS AGAINST FEDERAL REGULATIONS TO ALTER THIS SETTING OR OTHERWISE OPERATE THIS WOOD HEATER IN A MANNER INCONSISTENT WITH OPERATING INSTRUCTIONS IN THIS MANUAL.

 Never use gasoline, gasoline-type lantern fuel, kerosene, charcoal lighter fluid, ethyl alcohol or similar liquids to start or "reignite" a fire in this heater. Keep all such liquids well away from the heater while it is in use.

- Only power the appliance with fuel which has the characteristics as indicated in the section "FUEL" in the manual provided by the manufacturer.

 Do not overfire - If any external part starts to glow, you are overfiring. Reduce feed rate. Overfiring will void your warranty.

 **Warning against overfiring:**

- pellets must not be fed manually into the grate
- never add additional fuel by hand
- do not fill the hopper with any fuels other than wood pellet
- the residual pellets in the grate after a failed ignition must be removed before starting a new ignition process

 Do not use the appliance as an incinerator or in any way other than that for which it was designed.

- Do not use the appliance if the glass or seals on the door are damaged.
- Do not open the door during operation.

 For monitoring and inspection techniques ensuring heater is operating properly, including ensuring visible emissions are minimized, consult the section "CLEANING AND MAINTENANCE" and "OPERATING INSTRUCTIONS" (consult the section "MESSAGES - SAFETY WARNINGS - ANOMALIES").

Before carrying out any assembly, installation or ignition procedures, the enabled installer must check that the system has been manufactured in compliance with the applicable instructions provided by the manufacturer and in compliance with all relevant regulations. In particular, check:

- suitability of the room where the appliance is to be installed as well as any restrictions
- the existence of any other appliances
- fresh air intake

- ventilation within the area where the appliance is to be installed
- sufficient clean air flow for combustion: air cannot be taken from potentially polluted areas
- smoke evacuation system comprising a connecting flue pipe, flue and chimney.

Installation may also include a series of operations to be carried out correctly by enabled personnel and for which system compatibility must be guaranteed:

- connection to the air intake
- connection to the smoke evacuation system
- ventilation
- assembly and installation
- any necessary electrical or plumbing connections
- insulation
- start-up and operating tests, and where necessary calibration and adjustment
- cladding and trims
- presentation of additional documentation as prescribed by the regulations
- end user training by the installer on how to use and maintain the appliance
- checking and maintenance.

Other requirements for compliance may be necessary in relation to specifications required by the appropriate Authorities.

 **DO NOT USE MAKESHIFT COMPROMISES WHEN INSTALLING THIS APPLIANCE. DAMAGE AND/OR INJURY MAY RESULT.**

## 2 FUEL

 Under no circumstances use fuel other than pellets.

 Always refer to the manual "PRODUCT INFORMATION, INSTALLATION AND MAINTENANCE" in the section "FUEL".

### 3 REMOTE CONTROL

- i** Only some of the functions can be controlled using the remote control.
- The optional remote control is only available upon request.
  - If the remote control is fitted, a remote management system cannot be installed for the appliance: GPRS module (management via SMS); Wi-Fi module (management via app).

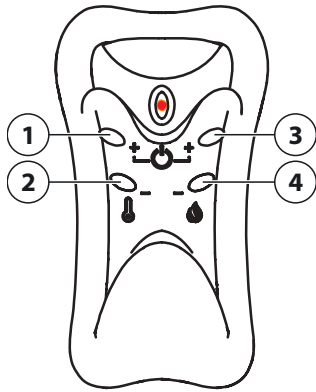

Fig. 1

#### 3.1 REMOTE CONTROL FUNCTIONS

##### Start-up / Shut down

By pressing keys 1-3 at the same time, the appliance starts-up or shuts down.

- 1 Key INCREASE TEMPERATURE**  
Selection of required room temperature
- 2 Key DECREASE TEMPERATURE**  
Selection of required room temperature
- 3 Key INCREASE POWER**  
Selection of required power level
- 4 Key DECREASE POWER**  
Selection of required power level

#### 3.2 CHANGING THE BATTERIES OF THE REMOTE CONTROL UNIT

- !** Only use ALKALINE batteries V23GA (8LR932) 12V.
- Rechargeable batteries are unsuitable for the remote control as they do not guarantee sufficient voltage for correct operation.
  - The new batteries must be of the same type as above, failure to comply with these instructions could lead to the risk of explosion.
  - The old batteries must be disposed of properly in compliance with the applicable laws in force.

### 4 APPLIANCE CONTROL PANEL

The product is equipped with a panel on the appliance itself which allows the user to control the various functions.

- i** The appliance is set with Italian as the default language. To change the language please refer to the section "SETTING THE LANGUAGE".

- i** Below is a list of the different types of panel. The position and type of panel with which your appliance is fitted, is indicated in the manual "PRODUCT INFORMATION, INSTALLATION AND MAINTENANCE" in the section "PART IDENTIFICATION".

#### 4.1 6 KEY CONTROL PANEL FUNCTIONS

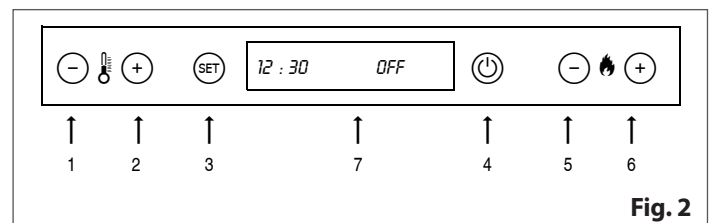

Fig. 2

##### Key functions with the appliance on

- 1 Key DECREASE TEMPERATURE**  
Selection of required room temperature
- 2 Key INCREASE TEMPERATURE**  
Selection of required room temperature
- 3 Key SET**  
Confirm the value set
- 4 Key ON/OFF**  
Manual start-up or shut-down of the product (press and hold)
- 5 Key DECREASE POWER**  
Selection of required power level  
LOCK KEYBOARD function
- 6 Key INCREASE POWER**  
Selection of required power level  
Access to the programming menu (press and hold)

##### Display functions

- 7 Display**  
Displays current time, ambient temperature, power level and set functions

- i** For use during the programming stage, refer to the section "ACCESS MENU KEYS".

### Keypad lock

To lock the buttons, press and hold (for approximately 10 seconds) until you see the message LOCK KEYBOARD. With the keypad locked, press any button and the message LOCKED KEYBOARD shows.

To release the buttons, press and hold (for approximately 10 seconds) until you see the message UNLOCK KEYBOARD.

## 4.2 SETTING THE LANGUAGE

The LANGUAGE function allows the user to select one of the available languages.

- Press for a few seconds
- using scroll through the menu until you reach LANGUAGE (LINGUA)
- confirm using
- with scroll through the menu until the message corresponding to the desired language is reached
- confirm using
- once confirmed the display shows the message FUNCTION ENABLED and the display automatically reverts to its initial readout.

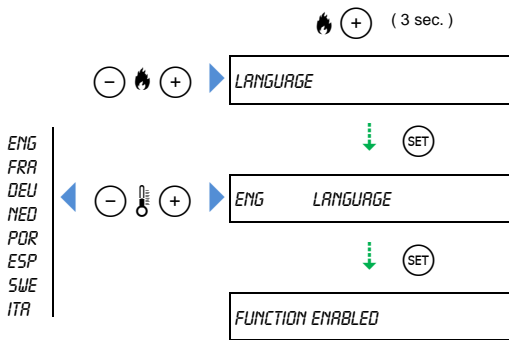

## 5 BEFORE STARTING-UP THE APPLIANCE

Before commissioning the appliance:

- read the instructions and the information, supplied in all forms together with the product and any accessories, as well as the documentation referred to in this manual carefully
- ensure that all indications provided by regulations and the manufacturer are strictly observed
- ensure that all cleaning and maintenance interventions necessary for the appliance and the system have been carried out.

A protective grill is provided inside the tank in some models. Removing this grille is strictly forbidden.

Before proceeding with start-up:

- the residual pellets in the grate must be removed
- check that the grate is positioned correctly in its seat and pushed towards the start-up hole
- check that the firebox door is closed and that the pellet tank is full or at least contains sufficient fuel to ensure appliance operation for the required time.

Failure to empty the grate of unburnt pellets can cause the formation of a significant amount of uncombusted fumes/gas inside the firebox the next time the appliance is ignited which, if there is no flame present, can compromise safety.

- Refer to the section "MESSAGE EMPTY GRATE".

During operation:

- some parts of the appliance (door, handle, controls, ceramic parts) may become extremely hot. Take great care and all necessary precautions, and make use of suitable protective devices, especially in the presence of children, the elderly, people with disabilities, and animals
- keep any combustible or heat-sensitive products away from the appliance (for example wooden furniture, carpets, curtains, fabric, clothes, ornaments, flammable liquids, etc.)
- the door must remain closed and the glass must not be broken in any way.

## 5.1 INFORMATION REGARDING THE FIRST START-UP

Before the first start-up, fill the auger following the indications given in the section "FILL AUGER".

- This operation may be necessary even if the tank empties.
- When the auger is empty, even partially, it is likely that the first start-up attempt will fail since the auger will require time to refill.

During the first few start-ups, odours will be released due to the evaporation of the greases or oily liquids used during production and present in the paint. During this stage, ensure that there is proper ventilation of the installation premises and avoid spending any prolonged time in the room since the vapours may be harmful to people or animals.



The first start-ups must be done so as to allow the appliance body to settle and the greases or oily liquids used during production and present in the paint to evaporate completely.

Therefore:

- operate the appliance at average power (or in the case of products fitted with a boiler and without power adjustment, at a set water temperature of approximately 60°C / 140°F) for the first 5-6 hours from the moment of the start-up (during this phase, the thermal expansion allows the appliance body to settle)
- following this settling phase, the appliance must be used at full power (or in the case of appliances with no power adjustment, at a set temperature of approximately 70°C / 158°F) for between 6-10 hours depending on the amount of paint which has to evaporate from the appliance body. This period of operation at full power must not necessarily be carried out continuously but can be divided during two time bands interrupted by at least 3-4 hours of appliance inactivity.

At the end of this period, greases or oily liquids will have evaporated and the paint stabilised, and the appliance should be used with appropriate settings for normal use.

If necessary, a new operating cycle at full power can be carried out in order to disperse any substances causing odours.

## 5.2 CHECK NETWORK VOLTAGE AND FREQUENCY

Some appliances when turned on are able to automatically recognise the electrical network voltage and frequency. If messages like those below appear:

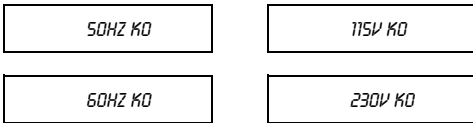

contact an authorised technician to modify the appliance settings. Only then will it be possible to start-up the appliance.

## 5.3 FILL AUGER

The FILL AUGER function allows the auger to be refilled with pellets and discharge the pellets into the grate so as to facilitate appliance start-up.

**!** When the appliance is new or the pellets have been completely used up, prior to start-up and ignition, carry out the FILL AUGER function.

- The FILL AUGER function is only possible when the appliance is in the OFF state and cold.

To carry out the FILL AUGER function:

- press for a few seconds
- with scroll through the menu until you reach the message FILL AUGER
- confirm using
- wait as long as is necessary for the operation to be completed

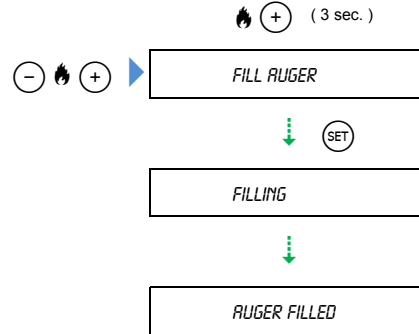

There will then be the request to empty the pellets from the grate. Refer to the section "MESSAGE EMPTY GRATE". Only then will it be possible to start-up the appliance.

### Message "NOT ALLOWED"

Indicates that it is not possible to carry out the function.

**!** The FILL AUGER function is only possible when the appliance is in the OFF state and cold.

## 6 STARTING THE APPLIANCE

Press and briefly hold down the ON/OFF key . Before accessing the normal operating mode, begin a start-up cycle as shown:

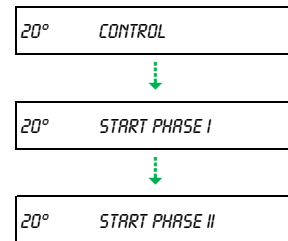

The appliance goes into steady normal functioning if the start cycle was successful.

**!** If combustion does not commence correctly during this start-up phase (within approximately 12-15 minutes), a warning message will be displayed. Refer to the section "MESSAGES - SAFETY WARNINGS - ANOMALIES".

## 7 CHANGE THE POWER

To change the power:

- press or
- select the required value using
- press to confirm the value set and go back to the initial display.

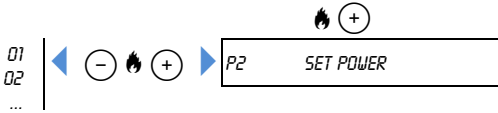

## 8 CHANGE ROOM TEMPERATURE

This parameter allows the user to set the appliance to minimum power when the set temperature has been reached.

**i** The room temperature can be set to between 7°C and 30°C (44°F / 86°F).

- The temperature can be detected via:
  - the probe on the appliance
  - an external thermostat (refer to the section "*OPERATION WITH AN EXTERNAL THERMOSTAT*").
- When the set temperature has been reached the readout "OK" appears and the appliance operates at minimum power even if the display shows the original set power level.

To change the set temperature:

- select the required value using
- press to confirm the value set and go back to the initial display.

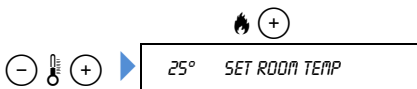

## 9 CHANGE THE VENTILATION

### Appliance with only one fan

The speed of the hot air extractor fan installed as standard is modulated automatically based on the power. For safety reasons, it cannot be modified by the user.

### Appliance with two fans

To change the ventilation (right fan):

- press

- select the required value using
- confirm using

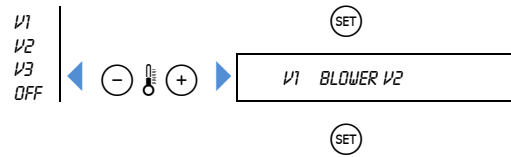

### BLOWER V2 - OFF

The hot air extractor fan is switched off.

For safety reasons, this setting is only available on some models and is allowed only where P1 and P2 are set.

## 10 SHUTTING-DOWN THE APPLIANCE

To shut-down the product:

- press and briefly hold down the ON/OFF key
- pellet loading is interrupted, while the room air fan and smoke extractor fan (if present) continue to run until the appliance has cooled
- when the appliance is off, the message OFF will be displayed.

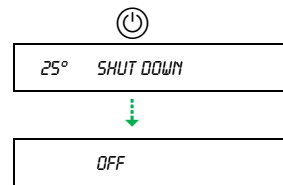

**⚠** Never disconnect the power supply at this stage. To do so could cause problems to the structure, damage the appliance and affect operation.

## 11 PARTICULAR SITUATIONS

### 11.1 RESTARTING DURING THE SHUT DOWN PHASE

The appliance will have finished the shut-down phase and the message "OFF" will have appeared on the display or it will still be in the shut-down phase and the message "SHUT DOWN" will be displayed.

If the user decides to restart the appliance pressing ON/OFF and the following message appears on the display:



this indicates that the appliance is still hot and the user must wait for the necessary cooling period. When it has cooled down, the message "OFF" appears on the display.

To restart the appliance, press ON/OFF once again.

## 11.2 SHUT DOWN DURING THE START-UP PHASE

The appliance has been turned off during start-up, on purpose or because of power failure.

Before turning the appliance off, some messages shown below might appear:

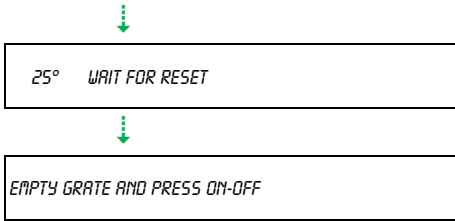

 Refer to the section "*MESSAGE EMPTY GRATE*".

## 11.3 SAFETY WARNINGS: HOW TO ACT

Before interrupting a safety warning:

- refer to the section "*MESSAGES - SAFETY WARNINGS - ANOMALIES*"
- identify the causes which have led to the alarm
- identify how best to intervene.

At that point:

- deactivate the appliance by pressing ON/OFF 
- The beep stops

Before turning the appliance off, some messages shown below might appear:

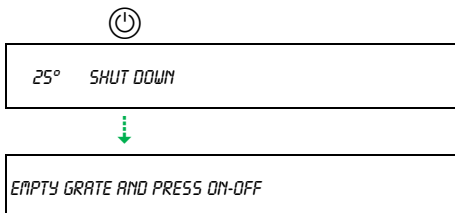

 Refer to the section "*MESSAGE EMPTY GRATE*".

 It is only possible to restart the appliance after having identified and removed the cause and restored the safety conditions (refer to the section "*STARTING THE APPLIANCE*"). Otherwise the appliance will continue to signal warnings and will not permit the start-up.

 If necessary contact the T.A.C. (authorized technical assistance centre).

## 11.4 OPERATION IN ADVERSE CLIMATIC CONDITIONS

Adverse climatic conditions (sudden changes in climate, wind, frost, etc.) may cause the appliance to malfunction and trip safety devices and the related warning messages.

 Check the operation of the appliance and, if necessary, see "*SAFETY WARNINGS: HOW TO ACT*".

## 12 MENU

### 12.1 MAIN MENU FUNCTIONS

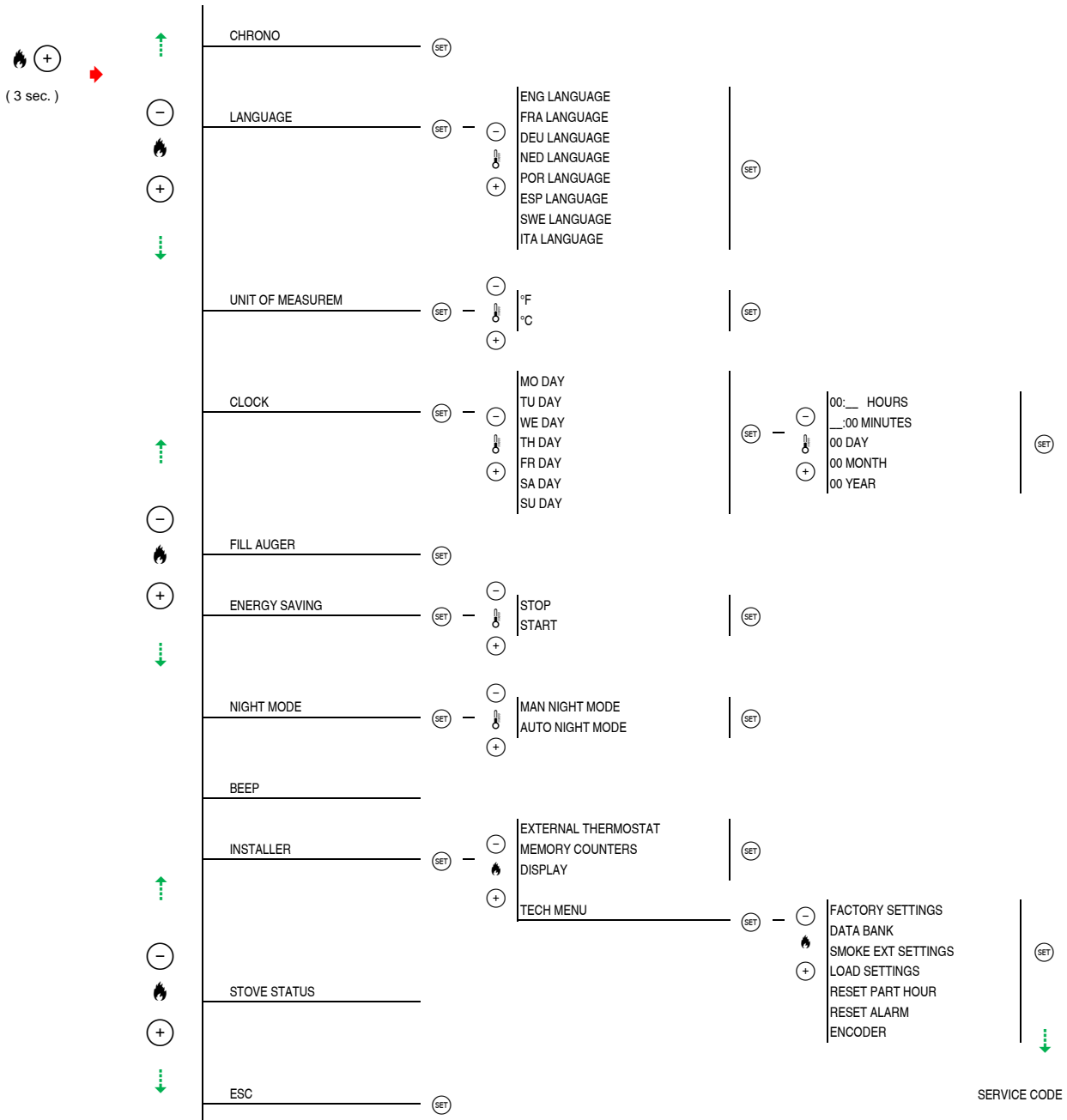

Depending on the model, some functions in the MENU are not displayed.

## 12.2 ACCESS MENU KEYS

To use the programming:

- press for at least 3 seconds to enter appliance programming
- scroll through the main menu displayed using
- press to confirm the function to be programmed
- set the various values using and confirm the selection using
- repeat the previous operation for each submenu required
- when menu programming has been completed, FUNCTION ENABLED appears on the display and the appliance returns to its initial display.

To go back to the previous level of the menu from any position within the programming menu, press once.

## 13 SET DATE AND TIME (CLOCK)

The CLOCK function allows the user to set the current day of the week, hour, minute, day, month, year on the appliance.

The appliance leaves the factory with the clock set, therefore simply check that the clock is giving the correct time or adjust for the current time. The correct time setting is required for the use of all time-dependant functions.

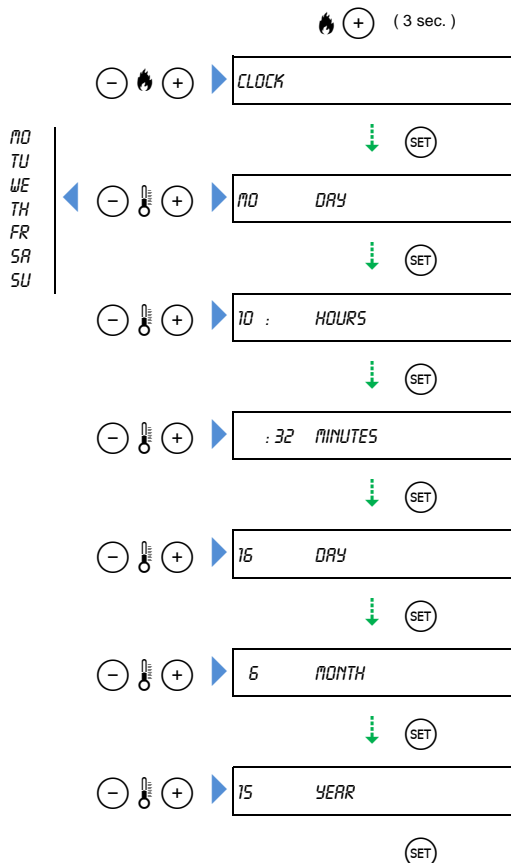

## 13.1 UNIT OF MEASUREMENT

The UNIT OF MEASUREMENT function allows you to change the unit of measurement for the temperature to either °F or °C.

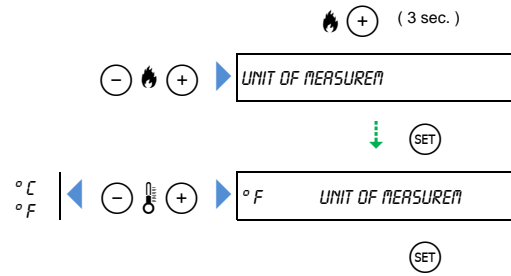

## 14 PROGRAMME CHRONO (CHRONO)

The CHRONO function allows the appliance to start up and shut down automatically on the basis of the times and days which have been set by the user and without the user needing to intervene manually.

This type of timer enables a maximum of 6 programs to be stored, and a single operating cycle per program. Operating cycle indicates a period between a start time and a stop time during which the appliance operates. For each program the days on which to activate it can be selected.

*For example, to set the following start-up times:  
from 06.00 to 09.00, from 11.30 to 13.00 and from 20.30 to 23.00 only on Monday, Tuesday and Thursday*

- enable program PR1 from 06.00 to 09.00 on the days MO, TU, TH
- enable program PR2 from 11.30 to 13.00 on the days MO, TU, TH
- enable program PR3 from 20.30 to 23.00 on the days MO, TU, TH from 06.00 to 08.30 and from 16:00 to 20:00 only on Friday and Saturday
- enable program PR4 from 06.00 to 08.30 on the days FR, SA
- enable program PR5 from 16.00 to 20.00 on the days FR, SA from 08.00 to 13.00 only on Sunday
- enable program PR6 from 08.00 to 13.00 on the days SU

If NIGHT MODE is set, the appliance power is not determined by the CHRONO settings, instead it is managed by the NIGHT MODE: the CHRONO mode only handles appliance start-up and shut down in the programmed time slots.

**!** If the ENERGY SAVING mode is set, CHRONO mode manages the appliance start-up and shut-down within the programmed time bands, while operation, start-up and shut-down according to the temperature are managed by the ENERGY SAVING mode.

**!** We recommend having only one program active in order to avoid program overlap.

- If the programmes are combined, it is necessary to set at least two hours between the interruption and the start-up time to avoid any overlapping. This means that the appliance cooling period which is necessary for correct operation can be respected.
- THE CLOCK MUST BE SYNCHRONISED BY SETTING CURRENT DAY, HOURS AND MINUTES THE FIRST TIME THE PROGRAM IS ACTIVATED, similar to buying a new watch and setting the current time.
- In the case of multiple active programs with overlapping time slots the unit will start with the first programmed start-up time and will always shut down at the first programmed shut-down time regardless of the program.

**i** To set the current time, refer to the section "SET DATE AND TIME (CLOCK)". This operation is necessary only the first time that the clock is activated.

**Example CHRONO function and sequence**

- 1 Program number
- 2 programme on (ON) or off (OFF)
- 3 START switch on time
- 4 STOP switch off time
- 5 Temperature
- 6 Power
- 7 Days of the week: MO= Monday ... SU= Sunday

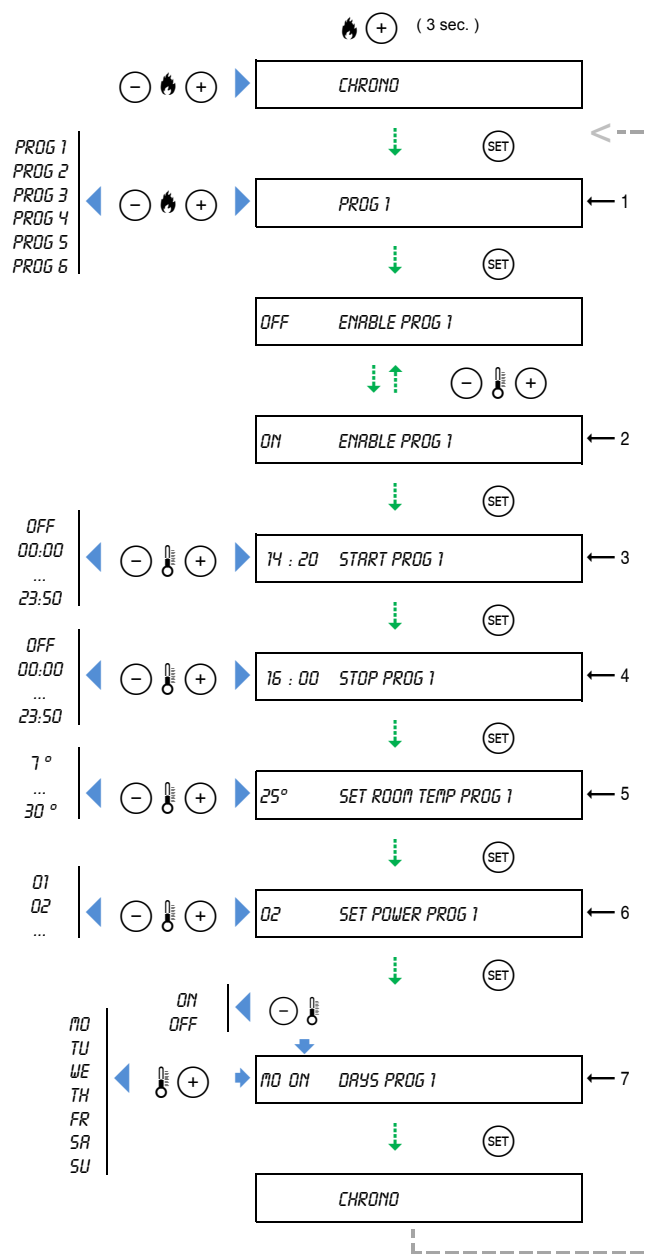

**i** Each individual programme is active if set to ON while it is deactivated if set to OFF.

- Programming on the clock advances in periods of ten-minutes.
- Pressing and holding the key or progressively increases the speed with which the time is changed.

**i** To go back to the previous level of the menu from any position within the programming menu, press once.

**START - OFF**

If the START function is set to OFF, the appliance will not start the start-up phase.

**STOP - OFF**

If the STOP function is set to OFF, the appliance will not start the shut down phase.

## 15 ENERGY SAVING

The ENERGY SAVING function allows the appliance to start-up and shut down automatically on the basis of the room temperature detected by the room temperature probe connected to the product.

**!** If the EXTERNAL THERMOSTAT STOP function is enabled, it is not possible to activate the ENERGY SAVING mode and vice-versa.

- If NIGHT MODE is enabled, it is not possible to activate the ENERGY SAVING mode and vice-versa.

**!** If the ENERGY SAVING mode is set, CHRONO mode manages the appliance start-up and shut-down within the programmed time bands, while operation, start-up and shut-down according to the temperature are managed by the ENERGY SAVING mode.

The work principle is as follows:

- when the temperature reaches the temperature which was set by the user (refer to the section "CHANGE ROOM TEMPERATURE"), the product automatically goes to power 1
- if operating at power 1 the room temperature continues to rise until it reaches the value set on the STOP function (for example +2°C / +4°F in relation to the programmed temperature) the product shuts down and goes into stand-by
- when the room temperature detected by the appliance falls to the temperature set by the user on the START function (for example -3°C / -6°F in relation to the programmed temperature), the appliance begins a new start-up phase and goes back to the power setting which was previously set by the user.

To use the appliance in ENERGY SAVING mode correctly, as regards the rooms to be heated and their thermal dispersion, it is recommended that you set the temperature thresholds and START/STOP values such as to avoid the appliance switching on and off continuously.

Where the time period between the appliance switch-off and switch-on procedures is less than 90 minutes, set the appliance to the minimum instead, turning off ENERGY SAVING (set ENERGY STOP to OFF).

**!** The appliance will only re-start when the temperatures detected by the appliance allow safe operation.

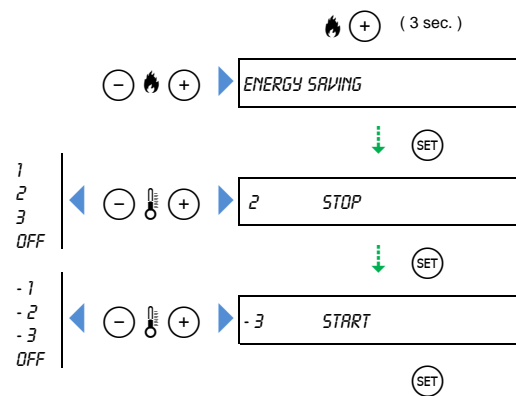
**ENERGY STOP**

This defines the variance in relation to the room temperature to activate shut down.

If the STOP function is OFF, upon reaching the set room temperature, the appliance will operate in the traditional way modulating power 1 without shutting down.

**i** Value to be set between +1 and +3°C (+2 / +6 °F).

**ENERGY START**

This defines the variance in relation to the room temperature to activate re-ignition.

If the START function is OFF, the appliance will not initiate the start-up phase after automatic shut down and will remain off.

**i** Value to be set between -1 and -3°C (+2 / +6 °F).

**Message "ENS"**

This indicates that the ENERGY SAVING function is set.

**Message "ENERGY OK"**

This indicates that the set temperature has been reached as set in the STOP function, the appliance begins the shut down phase and goes into stand-by.

**Message "OFF E"**

This indicates that the appliance has been shut down manually (or by some other triggered function) with STOP mode enabled.

**i** If the appliance is turned off manually, the programming has no effect and the appliance will not turn on again automatically.

- In this case if the product is to be restarted, this must be done manually.

## 16 NIGHT MODE

The NIGHT MODE function lets the user switch off the hot air ventilation motor (fitted as standard) manually or by setting a specific time slot. For safety reasons, the appliance switches to minimum power and heat is disseminated only by convection.

**i** This function is only present on some appliances.

**!** If NIGHT MODE is set, the appliance power is not determined by the CHRONO settings, instead it is managed by the NIGHT MODE: the CHRONO mode only handles appliance start-up and shut down in the programmed time slots.

- If NIGHT MODE is enabled, it is not possible to activate the ENERGY SAVING mode and vice-versa.
- NIGHT MODE cannot be activated for some models.

**i** When NIGHT MODE is activated, it is possible that ventilation shut down does not happen immediately but occurs later when operating conditions permit.

### NIGHT MODE - AUTO

Select NIGHT MODE - AUTO to automatically activate NIGHT MODE at the set times.

NIGHT MODE - START: identifies the shut down time of the hot air extractor fan.

NIGHT MODE - STOP: identifies the start-up time of the hot air extractor fan.

### Message "N"

This indicates that NIGHT MODE has started.

For safety reasons, only power values P1 (default value) and P2 can be set.

At the end, the appliance will go back to the power level set before NIGHT MODE.

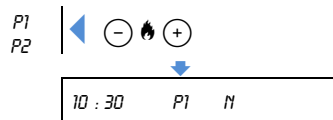

### Message "OFF N"

This indicates that the appliance has been shut down manually (or by some other triggered function) with NIGHT MODE enabled.

## 17 ENABLE ACOUSTIC SIGNAL (BEEP)

The BEEP function lets you manage the operation of the acoustic signal emitted by the device to signal messages-warnings.

### BEEP ON

The acoustic signal is enabled

### BEEP OFF

The acoustic signal is disabled

**i** Even if the beep is set to OFF, it will still be active should a safety warning activate.

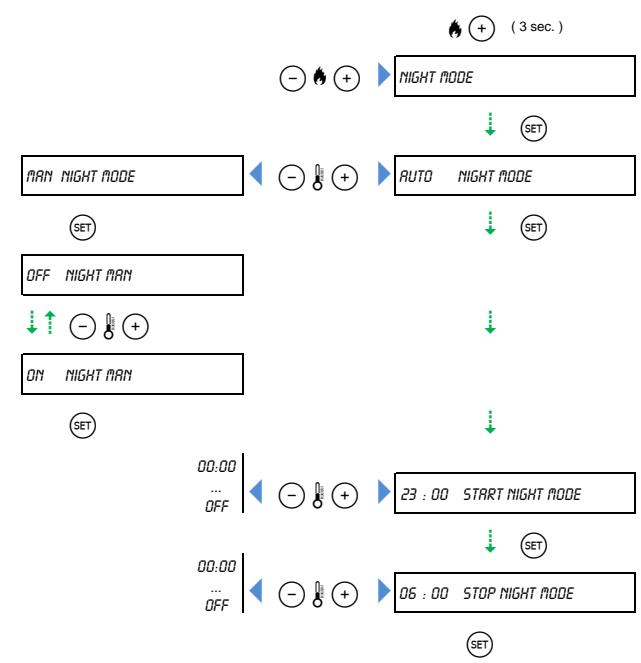
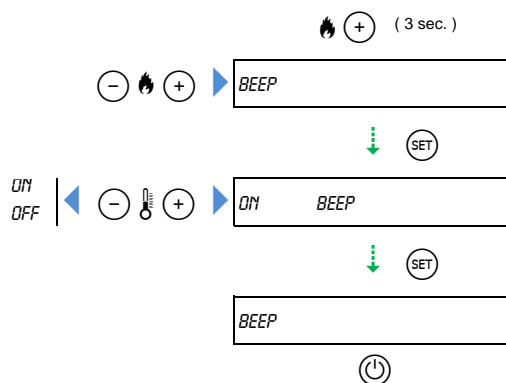

### NIGHT MODE - MAN

Select NIGHT MODE - MAN to activate NIGHT MODE manually.

NIGHT MAN - ON: the hot air extractor fan is always off.

NIGHT MAN - OFF: the hot air extractor fan is always on.



## 18 INSTALLER

Within the INSTALLER function, only the parameters indicated below can be changed freely.

The other parameters can only be used by an authorised technical assistance centre (authorized technical assistance centre) and require an access code.

Depending on the appliance, some parameters may not be visible.

### 18.1 N.PEL CONTACT

The N.PEL connection is used to connect up an external safety device, that may be required by local law to stop the appliance from functioning in case of a fault.

**i** Please refer to the manual for indications regarding the electrical connection "*PRODUCT INFORMATION, INSTALLATION AND MAINTENANCE*" in the section "*ELECTRICAL CONNECTIONS*".

- The external contact can be normally open or normally closed in type: choose the correct setting from the menu.

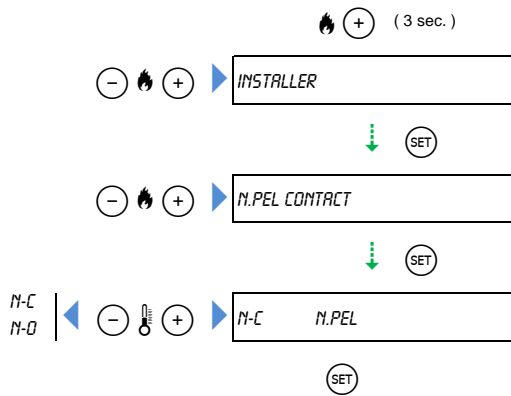

#### N.PEL N-O CONTACT

Select the section N-O if the appliance is connected to a contact that is normally open.

When the contact is open, the appliance operates normally. When the contact closes the electrical circuit, the appliance launches the shutdown procedure.

#### N.PEL N-C CONTACT

Select the section N-C if the appliance is connected to a contact that is normally closed.

When the contact is closed, the appliance operates normally. When the contact opens the electrical circuit, the appliance launches the shutdown procedure.

## 18.2 OPERATION WITH AN EXTERNAL THERMOSTAT

The EXTERNAL THERMOSTAT function allows the user to adjust appliance operation via an external contact, such as an external room thermostat.

**i** Please refer to the manual for indications regarding the electrical connection "*PRODUCT INFORMATION, INSTALLATION AND MAINTENANCE*" in the section "*ELECTRICAL CONNECTIONS*".

- The external contact can be normally open or normally closed in type: choose the correct setting from the menu.

**!** If the EXTERNAL THERMOSTAT STOP function is enabled, it is not possible to activate the ENERGY SAVING mode and vice-versa.

Operation of the external thermostat is conditioned by the set temperature of the appliance.

To enable the external thermostat:

- set the desired room temperature on the external thermostat
- set a maximum value of 30 °C (86 °F) on the stove.

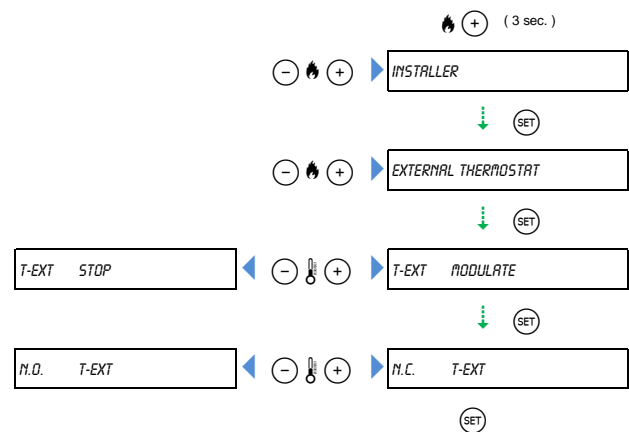

#### EXTERNAL THERMOSTAT MODULAT (T-EXT MODULATE)

When the temperature set on the thermostat is reached, the appliance power switches to the minimum.

The power previously set (for example, "P4") can still be seen on the display with the addition of the message "OK".



**EXTERNAL THERMOSTAT STOP (T-EXT STOP)**

When the temperature set is reached on the thermostat, the shut-down procedure begins and the appliance goes into stand-by. When the temperature falls below the value set on the thermostat, the appliance will start up again.

**i** The appliance will only re-start when the temperatures detected by the appliance allow safe operation.

**EXTERNAL THERMOSTAT N-O (T-EXT N-O)**

Select the section EXTERNAL THERMOSTAT N-O if the appliance is connected to a contact that is normally open. When the contact is open, the appliance operates normally. When the contact closes the electrical circuit, the appliance goes into MODULATE or STOP mode.

**EXTERNAL THERMOSTAT N-C (T-EXT N-C)**

Select the section EXTERNAL THERMOSTAT N-C if the appliance is connected to a contact that is normally closed. When the contact is closed, the appliance operates normally. When the contact opens the electrical circuit, the appliance goes into MODULATE or STOP mode.

**Message "T"**

Indicates that the EXTERNAL THERMOSTAT STOP function is active.

**Message "EXT THERM OK"**

This indicates that the set temperature has been reached as set in the STOP function, the appliance begins the shut down phase and goes into stand-by.

**i** If the appliance is turned off manually, the programming has no effect and the appliance will not turn on again automatically.  
 ■ In this case if the product is to be restarted, this must be done manually.

**18.3 MEMORY COUNTERS**

The MEMORY COUNTERS function displays information regarding:

- 1 total number of hours of the appliance
- 2 partial number of hours of the appliance: as of the last reset carried out by specialized personnel in the event of technical maintenance interventions. They cannot be reset by the user
- 3 number of start-ups
- 4 last 5 safety warnings
- 5 progressive number of the safety warning signal.

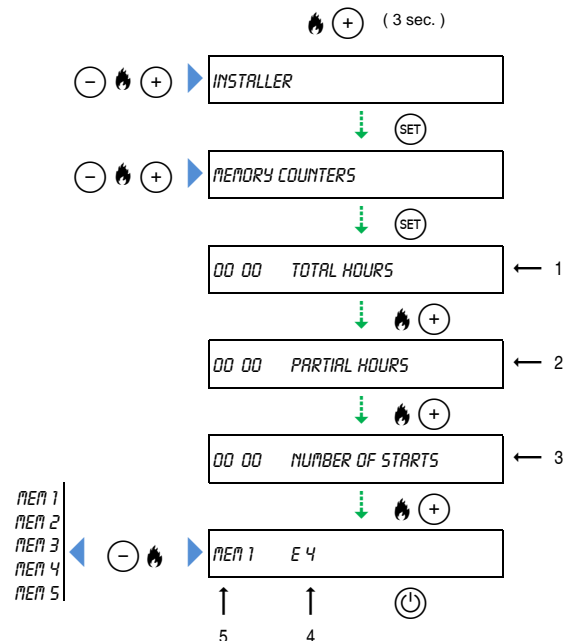

**18.4 DISPLAY**

The DISPLAY function allows the user to

- 1 select what is to appear on the main screen of the display
- 2 set the display to switch off when the keypad is not in use

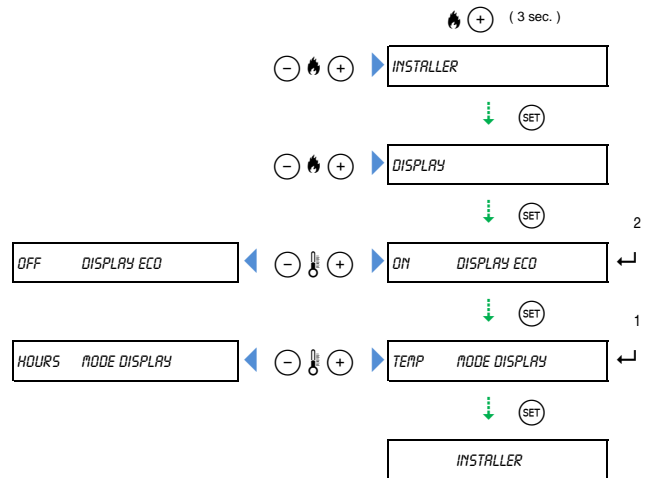

**MODE DISPLAY - HOURS**

Displays the time on the main screen.

**MODE DISPLAY - TEMP**

Displays the ambient temperature on the main screen.

**DISPLAY ECO - ON**

If the keypad is inactive for more than 1 minute, the display switches off until the next time it is used. Only a small illuminated point remains on the display indicating that the appliance is on.

**DISPLAY ECO - OFF**

The display is always visible.

**18.5 SETTINGS (TECH MENU)**

The functions in the SETTINGS menu (TECH MENU) can only be used by the TSC (authorised technical support centre) and require an access code.

**19 STOVE STATUS**

The STOVE STATUS function displays information (intended for specialist technicians) on:

- 1 temperature identified by the smoke probe
- 2 auger loading speed
- 3 room temperature detected by the appliance sensor
- 4 smoke extractor fan rotation speed.

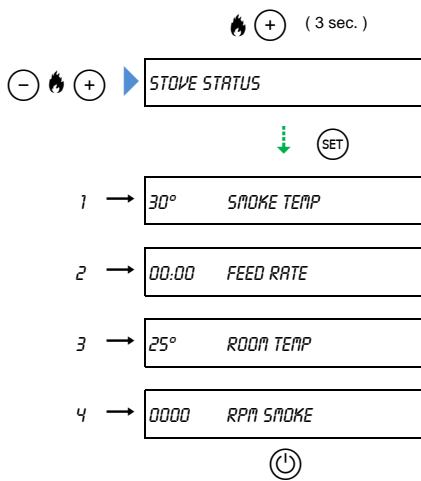

**20 MESSAGES - SAFETY WARNINGS - ANOMALIES**

**20.1 MESSAGES**

Below is a description of the warnings which may be displayed while the appliance is in operation and the interventions, if any, which should be carried out. Some of the warnings listed may not be relevant to your product.

**Message "CLEANING GRATE"**

This indicates that automatic cleaning of the grate is active. Activation times vary depending on the appliance operation. This operation is necessary in order to eliminate ash deposits or incrustations which do not allow the correct operation of the appliance and must be removed.

**i** No other intervention by the user is necessary.

**Message "EMPTY GRATE"**

EMPTY GRATE AND PRESS ON-OFF

This indicates that the user needs to clean the grate. It appears if for example the appliance has shut down, through the user's choice or due to a power failure during the start-up phase.

**!** Do not empty the grate inside the hopper as it may still contain unburnt pellets.

- Check that the grate is positioned correctly in its seat and pushed towards the start-up hole.

**!** If the grate is not emptied of uncombusted pellets, the next time the appliance is started up, a significant amount of uncombusted gas/smoke can form inside the firebox which will compromise safety if there is no flame present.

- A significant amount of unburned gas/smoke inside the firebox can cause the flame to ignite suddenly and in some cases, can cause the glass to explode.
- For appliances which are powered electrically, do not disconnect the power supply if unburned smoke/gas forms inside the firebox.

**i** When the smoke extractor fan shuts down:

- wait and make sure that the combustion of the pellets in the grate is complete and that the smoke extractor fan is off
- open the door, access the grate and remove any unburnt pellets
- replace the grate in its seat and close the door.

Via the menu, the user has to confirm that the operation has been carried out.

EMPTY GRATE AND PRESS ON-OFF



OFF

**Message "SERVICE TIME"**

This indicates that the time has come for scheduled maintenance of the appliance.

When appliance operation has reached 2000 hours the message "SERVICE TIME" alternating with "OFF" will appear on the screen when the appliance is switched off.

## OPERATING INSTRUCTIONS

Maintenance interventions by a technical assistance centre must be carried out regarding cleaning and careful maintenance so as to ensure continued safe and reliable appliance operation.

 The appliance may be used but an intervention from the technical assistance centre is required (Technical Assistance Centre).

### Message "EXT THERM OK"

 Refer to the section "*OPERATION WITH AN EXTERNAL THERMOSTAT*".

### Message "OFF T"

 Refer to the section "*OPERATION WITH AN EXTERNAL THERMOSTAT*".

### Message "OFF E"

 Refer to the section "*ENERGY SAVING*".

### Message "OFF N"

 Refer to the section "*NIGHT MODE*".

### Message "P1 N"

 Refer to the section "*NIGHT MODE*".

### Message "ENERGY OK"

 Refer to the section "*ENERGY SAVING*".

### Message "ENS"

 Refer to the section "*ENERGY SAVING*".

### Message "WAIT FOR OFF"

 Refer to the section "*RESTARTING DURING THE SHUT DOWN PHASE*".

### Message "RESTART POWER FAILURE"

 Refer to the section "*OTHER ANOMALIES - POWER SUPPLY FAILURE*".

### Message "NOT ALLOWED"

 Refer to the section "*FILL AUGER*".

### Message "LOCKED KEYBOARD"

Signals that the safety mechanism against accidental button pressing is active. To use the menu, unlock the keypad.

 Refer to the section "*APPLIANCE CONTROL PANEL*".

### Message "CLOSE"

This signals that the pellet hopper cover is open. Check the pellet load in the hopper, fill it if necessary and then close the cover.

The message is accompanied by a beep. After the maximum pre-set time (approximately 1 minute), the alarms are triggered.

## 20.2 SAFETY WARNINGS

Below are the warnings which appear together with the acoustic signals which may be activated in the case of malfunctions.

 All work is to be carried out when the fire is out, the appliance has cooled down completely and with the power cable of the product itself and/or any other accessories disconnected.

- Unauthorized tampering of the appliance and / or the use of non-original parts, inefficient or failure to carry out maintenance, use and installation which does not respect the indications provided by regulations and the manufacturer, aside from creating a hazardous situation for the operator's safety, will void the warranty and release the manufacturer from any liability.
- In the above cases, the intervention of a technical assistance centre is not to be considered covered by guarantee as it is not due to product defect.

 Some of the interventions described may be carried out by the user while for others, it is necessary to contact the technical assistance centre (Technical Assistance Centre).

- As pursuant to law, qualified personnel must resolve anomalies or make repairs that require work to be performed on the components inside the covering or combustion chamber. It is therefore recommended that only authorized technical assistance centres are used
- Only contact the technical assistance centre after having consulted the instructions supplied together with the appliance and any accessories.

 Refer to the section "*SAFETY WARNINGS: HOW TO ACT*".

### Warning "E1"

The pressure switch activates. Electrical power to the auger is interrupted, thus stopping pellet feed to the grate, followed by the appliance shut down phase beginning.

POSSIBLE CAUSES	ACTION
<b>Interventions which may be carried out by the user</b>	
No cleaning grate	Make sure that the grate is not obstructed with pellets of combustion residuals. Refer to the manual " <i>PRODUCT INFORMATION, INSTALLATION AND MAINTENANCE</i> " in the section " <i>CLEANING THE GRATE AND GRATE SUPPORT</i> "
Air entering the firebox	Check that the firebox door and the external ash drawer (if present) are closed

### Operations which require the intervention of the T.A.C.

Smoke evacuation system obstructed - no draught	Check and clean the smoke evacuation system
Smoke flue too long	Check that the appliance and system have been installed correctly
Door and smoke flue sealing gaskets are deteriorated	Check and replace if necessary with an original spare part
Hose connection of the depressiometer is clogged	Disconnect and clean the hose connection of the depressiometer.
Silicone pipe for the depressiometer clogged or broken	Disconnect and clean the silicone pipe and replace if necessary with an original spare part
Smoke aspirator is faulty	Check and replace if necessary with an original spare part
Faulty electronic board	Check and replace if necessary with an original spare part
Auger motor faulty	Check and replace if necessary with an original spare part

**Warning "E2"**

On appliance start-up, a malfunction in the pressure switch has been detected. The shut down phase begins.

POSSIBLE CAUSES	ACTION
<b>Operations which require the intervention of the T.A.C.</b>	
Pressure switch faulty	Check and replace if necessary with an original spare part
Excessive draught of the flue or adverse weather conditions	Check and inspect the flue
Auger motor faulty	Check and inspect that connections are in accordance with the wiring diagram and replace if necessary with original spare parts

**Warning "E3"**

The temperature in the pellet hopper has exceeded the limit set and the thermostat triggers in order to prevent an excessive difference in the temperature. Electrical power to the auger is interrupted, thus stopping pellet feed to the grate, followed by the appliance shut down phase beginning.

POSSIBLE CAUSES	ACTION
<b>Interventions which may be carried out by the user</b>	
The use of non compliant pellets (type, composition, size etc.)	Refer to the section "FUEL"
<b>Operations which require the intervention of the T.A.C.</b>	
Smoke evacuation system obstructed - no draught	Check and clean the smoke evacuation system
Problems with ventilation or heat dispersion	Check that the appliance has been installed correctly (safety distances, aeration, parameters, smoke evacuation duct too long)
Faulty thermostat or incorrect connection	Check and inspect that connections are in accordance with the wiring diagram and replace if necessary with original spare parts
Faulty electronic board	Check and replace if necessary with an original spare part

**i** If the appliance is equipped with a manually rearmed thermostat, this thermostat must be rearmed manually. Refer to the manual "PRODUCT INFORMATION, INSTALLATION AND MAINTENANCE" in the section "SAFETY DEVICES" and "CLEANING AND MAINTENANCE".

**Warning "E4"**

The temperature detected by the smoke probe has exceeded the set safety limit. Electrical power to the auger is interrupted, thus stopping pellet feed to the grate, followed by the appliance shut down phase beginning.

POSSIBLE CAUSES	ACTION
<b>Interventions which may be carried out by the user</b>	
Non compliant pellets are being used (type, composition, size etc.)	Refer to the section "FUEL"
<b>Operations which require the intervention of the T.A.C.</b>	
Smoke evacuation system obstructed - no draught	Check and clean the smoke evacuation system
Problems with ventilation or heat dispersion	Check that the appliance has been installed correctly (safety distances, aeration, parameters, smoke evacuation duct too long)
Faulty electronic board	Check and replace if necessary with an original spare part
Smoke temperature control probe is faulty or connected incorrectly	Check and inspect that connections are in accordance with the wiring diagram and replace if necessary with original spare parts
Incorrect parameter settings	Check that the parameters have been calibrated correctly

**Warning "E6"**

During operation an anomaly has been detected on the auger with continuous pellet feed. The shut down phase begins.

POSSIBLE CAUSES	ACTION
<b>Operations which require the intervention of the T.A.C.</b>	
Auger fault	Check and replace if necessary with an original spare part
Faulty electronic board	Check and replace if necessary with an original spare part
Incorrect parameter settings	Check that the parameters have been calibrated correctly

**Warning "E7"**

The temperature detected by the smoke probe is below the minimum operating temperature. The appliance shut down phase begins.

POSSIBLE CAUSES	ACTION
<b>Interventions which may be carried out by the user</b>	
Tank empty or irregular evacuation	Check the pellet load in the hopper and fill it if necessary. Refer to the section "FUEL"
Non compliant pellets are being used (type, composition, size etc.)	Refer to the section "FUEL"
No cleaning grate	Make sure that the grate is not obstructed with pellets of combustion residuals. Refer to the manual "PRODUCT INFORMATION, INSTALLATION AND MAINTENANCE" in the section "CLEANING THE GRATE AND GRATE SUPPORT"

**Operations which require the intervention of the T.A.C.**

Faulty electronic board	Check and replace if necessary with an original spare part
-------------------------	--

**Warning "E8"**

A malfunction has been detected in the smoke probe.

POSSIBLE CAUSES	ACTION
<b>Operations which require the intervention of the T.A.C.</b>	
Faulty electronic board	Check and replace if necessary with an original spare part
Smoke temperature control probe is faulty, has accidentally been disconnected or connected incorrectly	Check and inspect that connections are in accordance with the wiring diagram and replace if necessary with original spare parts

**Warning "E9"**

During start-up, the appliance does not reach the start-up temperature threshold within the set time.

POSSIBLE CAUSES	ACTION
<b>Interventions which may be carried out by the user</b>	
Tank empty or irregular evacuation	Check the pellet load in the hopper and fill it if necessary. Refer to the section "FUEL"
Non compliant pellets are being used (type, composition, size etc.)	Refer to the section "FUEL"
Auger has not fully loaded	Refer to the section "FILL AUGER"
No cleaning grate	Make sure that the grate is not obstructed with pellets of combustion residuals. Refer to the manual "PRODUCT INFORMATION, INSTALLATION AND MAINTENANCE" in the section "CLEANING THE GRATE AND GRATE SUPPORT"

**Operations which require the intervention of the T.A.C.**

Lighter faulty or disconnected	Check and replace if necessary with an original spare part
Faulty electronic board	Check and replace if necessary with an original spare part

**Warning "E10"**

A malfunction has been detected when reading the room temperature. No acoustic signal is emitted. The setback does not shut down the stove that continues to function normally according to power level set. However, the room temperature set by the user is not taken into account.

POSSIBLE CAUSES	ACTION
<b>Interventions which may be carried out by the user</b>	
Room temperature probe disconnected	Check whether the room probe is connected and re-insert it if necessary. Refer to the manual "PRODUCT INFORMATION, INSTALLATION AND MAINTENANCE" in the section "ELECTRICAL CONNECTIONS"
<b>Operations which require the intervention of the T.A.C.</b>	
Room temperature probe faulty	Check and replace if necessary with an original spare part
Faulty electronic board	Check and replace if necessary with an original spare part

**Warning "E12"**

A malfunction has been detected in the smoke extractor fan. The appliance shut down phase begins.

POSSIBLE CAUSES	ACTION
<b>Operations which require the intervention of the T.A.C.</b>	
Encoder faulty or disconnected	Check and inspect that connections are in accordance with the wiring diagram and replace if necessary with original spare parts
Faulty electronic board	Check and replace if necessary with an original spare part
Protection fuses	Check and replace if necessary with an original spare part

**Warning "E13"**

 Only present in products equipped with a hopper cover open sensor.

During operation or when the pellets are being loaded the hopper cover has remained open for longer than the maximum pre-set time (1 minute). The shut down phase begins.

POSSIBLE CAUSES	ACTION
<b>Interventions which may be carried out by the user</b>	
The lid of the pellet hopper is open	Check the pellet load in the hopper, fill it if necessary and then close the cover
<b>Operations which require the intervention of the T.A.C.</b>	
The hopper sensor is faulty or has been incorrectly connected	Check and inspect that connections are in accordance with the wiring diagram and replace if necessary with original spare parts
Faulty electronic board	Check and replace if necessary with an original spare part

**Warning "E14"**

The appliance has not reached the start-up temperature threshold within the set time.

POSSIBLE CAUSES	ACTION
<b>Interventions which may be carried out by the user</b>	
Tank empty or irregular evacuation	Check the pellet load in the hopper and fill it if necessary. Refer to the section "FUEL"
Non compliant pellets are being used (type, composition, size etc.)	Refer to the section "FUEL"
No cleaning grate	Make sure that the grate is not obstructed with pellets of combustion residuals. Refer to the manual "PRODUCT INFORMATION, INSTALLATION AND MAINTENANCE" in the section "CLEANING THE GRATE AND GRATE SUPPORT"

**Operations which require the intervention of the T.A.C.**

Faulty electronic board	Check and replace if necessary with an original spare part
-------------------------	--

**Warning "E19"**

An external safety device connected to the N.PEL / PELLETT contact has been tripped. The appliance launches the shutdown procedure. Please seek assistance from the T.A.C.

**20.3 OTHER ANOMALIES**

 If any part of the appliance or the connecting flue pipe leaks smoke while the appliance is in use, shut down the appliance immediately and air the room(s). Once cooled try to look for the cause of the leak and contact the technical assistance centre

**Occasional failure to start-up**

Any occasional start-up failure of the appliance may be caused by:

- pellet composition or size which does not correspond to the specifications given in this manual (refer to the section "FUEL")
- insufficient electrical power.

 In the above cases, the intervention of a technical assistance centre is not to be considered covered by guarantee as it is not due to product defect.



**The control panel does not switch on**

POSSIBLE CAUSES	ACTION
<b>Interventions which may be carried out by the user</b>	
Power supply failure from the building	Check the electrical system of the building
The appliance is not powered	Check that the plugs are connected to the network and the appliance and that any system switches are active
Blown fuse in the power supply plug (if located on the outside of the product without needing to remove parts of the cladding)	Check and replace if necessary with an original spare part. Refer to the manual " <i>INFORMATION ON THE APPLIANCE, INSTALLATION AND MAINTENANCE</i> " in the section " <i>REPLACING THE FUSES</i> "

**Operations which require the intervention of the T.A.C.**

Protection fuses	Check and replace if necessary with an original spare part
Faulty power cable	Check and replace if necessary with an original spare part
Faulty control panel	Check and replace if necessary with an original spare part
Faulty connection cable to control panel	Check and replace if necessary with an original spare part
Faulty electronic board	Check and replace if necessary with an original spare part

**The stove runs for 10 minutes then shuts down**

This situation is also signalled by a safety warning, therefore please refer to the relevant explanation of the warnings which appear.

**Power supply failure (power failure)**

During operation, it is possible that there may be a power supply failure (power failure). This is what can be expected depending on the situation:

**During start-up**

- when power is restored, the appliance is reactivated and the shut down procedure begins.

**During operation:****for less than 30 seconds**

- the appliance continues to function as normal when power is restored.

**for more than 30 seconds**

- when power is restored, the appliance switches off and when the conditions permit, it starts-up again.

**With CHRONO settings:****power failure around the start time**

- command non executed
- the appliance does not re-start when power is restored.

**power failure around the stop time**

- command non executed
- the appliance performs as described for normal operation.

**power failure during the programmed operation time slot**

- the appliance performs as described for normal operation.

**One item in the menu cannot be accessed**

POSSIBLE CAUSES	ACTION
The function requires an access code	The function is only for a technical assistance centre with an access key
The function cannot be accessed since it is incompatible with other settings	Refer to the instructions in the section corresponding to the function



Blank page with horizontal dashed lines for writing.



Via Montello, 22  
31011 Casella d'Asolo (TV) - ITALY  
Tel. +39.04235271 - Fax +39.042355178  
[www.piazzetta.com](http://www.piazzetta.com)  
e-mail:[infopiazzetta@piazzetta.it](mailto:infopiazzetta@piazzetta.it)