



OPERATING INSTRUCTIONS

"technika" Range - 4 FACES SUSPENDU

www.totemfire.com



Contents

1	Foreword	2
2	Operating instructions	2
2.1	Basic safety rules	2
2.1.1	General points	2
2.1.2	Fire hazard zone	2
2.1.3	In the event of fire propagation in the flue.....	2
2.2	How does Totem fireplace work?.....	2
2.2.1	Door.....	2
2.3	Normal operation.....	3
2.3.1	Reflectors	3
2.4	Using your appliance for the first time.....	4
2.5	How to operate the fire.....	4
2.5.1	Lighting.....	4
2.5.2	Adding wood.....	4
2.5.3	Extinction.....	4
2.6	Initial checks in case of poor functioning	4
2.7	Maintenance guide.....	4
2.7.1	Cleaning the glass.....	4
2.7.2	Cleaning the fireplace.....	5
2.7.3	Maintenance and Chimney Sweeping.....	5
2.8	Maintenance record	6
3	Basic information about firewood	7
3.1	General points	7
3.2	Drying of wood and its moisture content.....	8
3.3	Types of fuel which are forbidden	8
4	Warranty.....	8
4.1	Statutory warranty	8
4.2	Contract guarantee.....	8
4.3	The following are not covered by the warranty	8

1 Foreword

You have purchased a Totem fireplace, thank you for your custom. Read these operating instructions carefully in order to obtain the best and safest use of your new installation. Totem fireplaces are high-tech, high-performance appliances, in particular with regard to safety. Installation of the fireplace, its accessories and the materials which surround it must be carried out according to best practice and in compliance with all local and national regulations as well as all national and European standards. A qualified professional shall have ensured, in particular, that the characteristics of the chimney flue and its environment are suitable for the fireplace to be installed. Any modification to your Totem fireplace will render the warranty null and void. If you have any questions about how the appliance works, please contact your fitter. The explanations in this manual only apply to the Totem Epi, Lateral and 3 Faces Technika fireplace. For further information, consult our Internet site: www.totemfire.com

2 Operating instructions

2.1 Basic safety rules

2.1.1 General points

- Your Totem fireplace is fitted with foldaway swinging doors which allow it to operate with the door lowered (shut) in complete safety and an easy wood loading door open.
- It is essential to wear protective gloves or use the safe handling tool to handle the door. When the door is lowered (shut) the accessible surfaces of the frame of the door and the vitro-ceramics rise considerably in temperature when the appliance is in operation and can cause burns when touched.
- Explain the risks of burns to children and ensure that they are not close to the fireplace when it is in use.
- It is strictly forbidden to open the swinging door when the appliance is in use

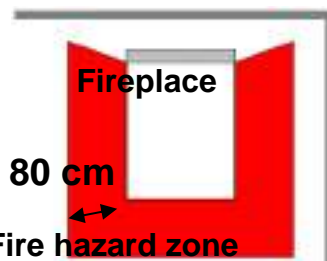

2.1.2 Fire hazard zone

Do not store flammable items within an 80 cm radius around the fireplace door. (logs, tables, chairs, firelighters...) No flammable material must be placed in the appliance's fire hazard zone.

2.1.3 In the event of fire propagation in the flue

If maintenance and operating conditions are adhered to, there is no risk of fire in your flue. Nevertheless, please read these rules concerning chimney flue fires. **Never use water to put out the fire.** Water causes thermal shock which could cause the bricks and vitro-ceramics of the fireplace to explode. Close all the combustion air inlets, the smoke damper trap as well as the door, using the safe handling tool to extinguish the fire. Move any flammable objects away from the fireplace. Call the fire brigade. In the European Union dial 112

Before using again, it is compulsory to have the entire installation (especially the ducts) checked and cleaned by a qualified professional.

A fit for use certificate provided by a professional is compulsory.

2.2 How does Totem fireplace work?

HEATING BY RADIATION AND CONVECTION

Burning wood produces heat by radiation and convection. To optimise radiation of the fire, Technika fireplaces are equipped with very large panes of glass and reflectors (see p14). The reflectors reduce the temperature of the smoke evacuated and increase that of the fire. In this way, they directly contribute to improving your appliance's performance. Convection air is taken from inside the house at floor level; it increases in temperature by circulating around the fireplace and inside its double lining before being redistributed via the 4 hot air vents.

Warmed air, redistributed into your house

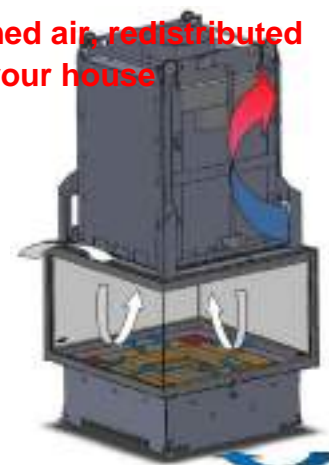

Ambient air

2.2.1 Door

Foldaway door

Your Totem fireplace is fitted with a foldaway door. This is used to make the appliance function on a daily basis.

The foldaway door must not be open when using the fireplace except when loading wood.

The fireplace is designed to operate with the door closed in order to optimise heating performance and allow you to enjoy the fire in complete safety.

To prepare the fire and add wood raise the door. Our doors are fitted with a stainless steel handle to facilitate use.

When the appliance is hot, use a glove or the safe handling tool to operate it. Open the door by a few centimeters

before fully opening to prevent down draughts. **Note: To prevent smoke from being discharged into your house, never allow your fireplace to operate with the door half open.**

The Totem safe handling tool

The safe handling tool, supplied with every fireplace, allows the various elements of the fireplace to be handled without risk of burns.



Door raised



Door lowered

Forge effect When the appliance is functioning with the door closed, there must be no passage of air under the door.

Check that nothing is preventing the door from closing correctly (embers, pieces of wood...) The air flow entering the fireplace is accelerated by the reduced passage under the door.

This air causes the fire to be over active. The wood burns too quickly

The appliance becomes less efficient.

AIR

The door must be **COMPLETELY** closed.



Swinging door The swinging door must only be used for cleaning the glass, never for operation with the door open or for loading wood. To open the swinging door, lower the door to the maximum, Push the latches (1) Pull the swinging door (2) To close the swinging door, push the door in the direction of the fireplace. Check that the latches lock correctly.

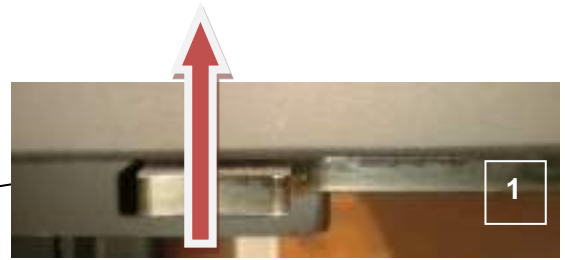
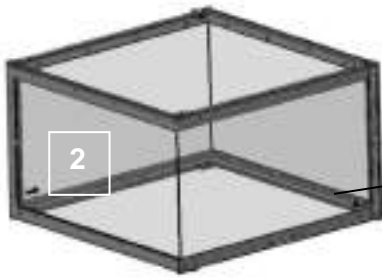

2.3 Normal operation

PRIMARY AIR

Fresh air is distributed under the hearth floor to intensify the fire. Some of the fresh air enters through the edges of the hearth floor; this improves burning and reduces down draughts. The primary air control connected to the air intake flap allows you to control the rate of your fire and adjust its power.

PRIMARY AIR



A hole in the control has been created to allow you to handle it using the safe handling tool and in this way prevent burns.

N.B.: Your wood burns with dark flames (orangey-yellow) – this is a sign of insufficient air: increase the air input.

SECONDARY AIR

Above the glass panes, secondary air creates a film of air along them which reduces carbon deposits. A strip in the upper part of the glass has been installed to allow you to manage this air. To do so, unscrew

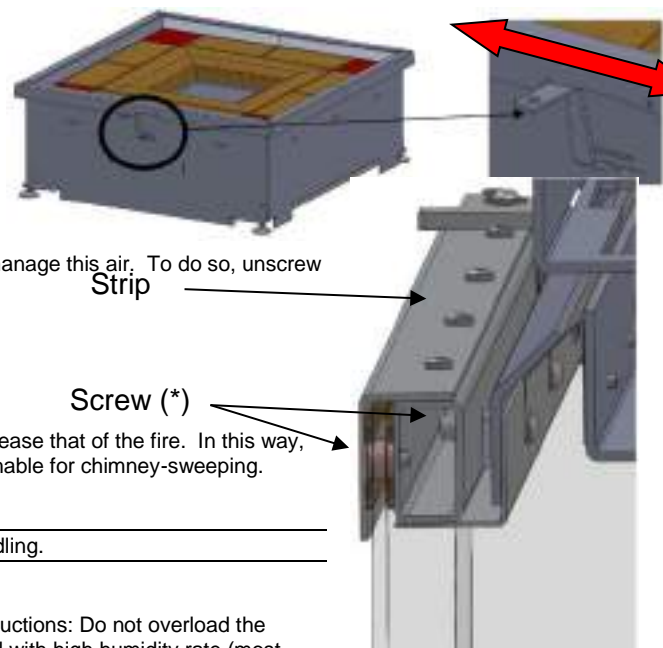

Strip

Screw (*)

3.1 Reflectors

The TOTEM FIRE Company recommends that they are installed to improve efficiency.

The reflectors fitted in Technika reduce the temperature of the evacuated smoke and increase that of the fire. In this way, they directly contribute to improving the performance of your equipment. They are detachable for chimney-sweeping.

Vermiculite is a fragile material, please take care when handling.

Warning : The vermiculite is a fragile material, it is important to respect the following instructions: Do not overload the fireplace and use it at a reduced pace (combustion air reduced). Do not use heating wood with high humidity rate (most preferably <18%). A wrong use of the fireplace and a bad quality heating wood may cause a degradation of your vermiculite reflector.

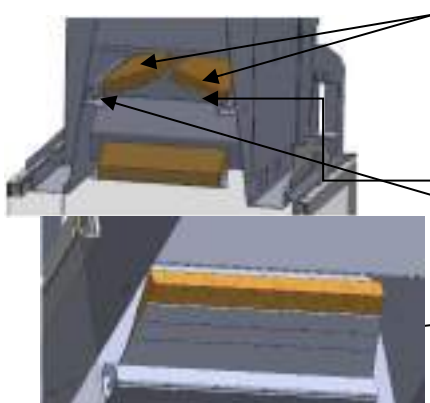

4 vermiculite reflectors

Reflector support

The reflectors are placed on a divisible steel sheet. It is therefore possible to increase the smoke flow surface area by breaking the micro-seams of the divisible sections; this adjustment must only be carried out by the fitter.

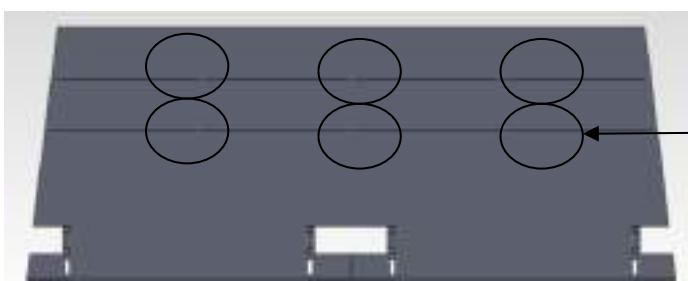

Micro-seams

2.4 Using your appliance for the first time

Before lighting your fire for the first time, remove any documents and accessories it may contain. Also check the ash pit. Allow covering materials to dry (rough plaster, finishing plaster...) before using the appliance for the first time to prevent them from deteriorating by drying too quickly. During the first few hours of use, maintain a moderate fire to allow the materials time to cure. Each time you use the fireplace, gradually increase the load of wood. Smoke and odours may be released the first few times you use the fire. They are due to final evaporation of paint, the sheet metal preservative oil and drying bricks. If this occurs, ensure that the room in which the appliance is located is well ventilated.

2.5 How to operate the fire

2.5.1 Lighting

If you have not used your appliance for a long time, check that none of your fireplace's air passages are obstructed (chimney flue, outside air delivery pipe, convection and ventilation grille) before lighting. - Open the foldaway door (1) - Open the combustion air control (2)

- Place two or three chopped logs in the centre of the fireplace.
- Place dry and resawn kindling on top. Position your wood so as to allow air to circulate freely.
- Place paper or firelighter on the kindling.] - Light the paper or firelighter
- Allow the flue to increase gradually in temperature without causing the fire to become over active.
- Allow about fifteen minutes for your fire to catch before fully lowering the door using a glove or the safe handling tool.

Once the fire has started, you can reduce the combustion air supply as well as the smoke evacuation flow rate.

Load wood before the fire has become a bed of embers.

Recommendation: Never overload your fireplace with wood, especially when starting it up.

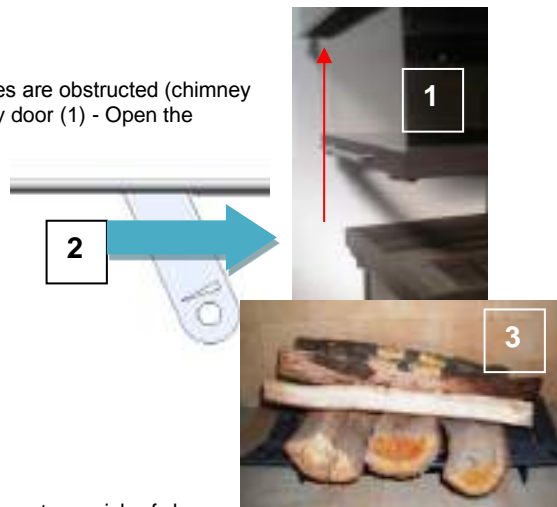

2.5.2 Adding wood

To open the door during operation, slightly raise the door, pausing before fully opening it to prevent any risk of down draught. Use protective gloves or the Totem safe handling tool to operate the fireplace's door handle in order to protect you from burns. **Tip: For optimal heating, align your logs on the appliance's ash tray. Maximum loads of dry wood per hour of operation**

Maximum	Weight	50 cm logs	Equivalence in kW
Latéral 800 Technika	4,5 kg	3 à 4	20
3 Faces 800	4,5 kg	3 à 4	20

Maximum output: 20 kW **Rated output:** 14kW The rated output of 14 kW corresponds to approximately 3 kg of loaded wood, i.e. 3 logs measuring 35 cm. It is at this output that your fireplace performs optimally. **Example output:** 9kW However, depending on the size of your house and the temperatures required, you can use the fireplace at a lower output; by loading approximately 2 kg of wood (for example 2 logs measuring 35 cm), the power released by your fireplace will be approximately 9 kW.



4 logs weighing approximately 5 kg

2.5.3 Extinction

Fully lower the door. Close the combustion air control. Allow the fire to go out.

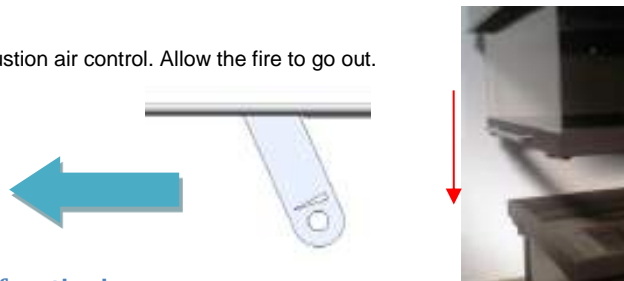

2.6 Initial checks in case of poor functioning

- **When the door is closed**, the wood burns too quickly and the fire is over active: - Is the fire door shut properly? - Are the reflectors in place? - Do you use recommended firewood? - Is the wood too small?
- **When the door is closed**, the fireplace does not heat up sufficiently: - Are the ventilation and convection grilles clogged up? - Is the fireplace door correctly shut? - Have you loaded enough wood?
- The wood does not burn well: - Is the wood too humid? - Are the pieces of wood too large? If so, saw them.

2.7 Maintenance guide

Before carrying out any maintenance on your appliance, wait for it to completely cool down to prevent any risk of burns or fire.

2.7.1 Cleaning the glass

Carefully cover the floor below the door so as not to mark it. Take a pair of gloves, a bucket of warm water, a sponge, washing up liquid or a product for cleaning glass and newspaper. Never use abrasive oven products, this damages the door gaskets. Open the swinging door. Apply the product on the inside of the glass and allow it time to act. Do not spray the product directly onto the glass. Spray it onto a cloth then wipe the glass with the cloth. During this time, empty the ash tray and clean the fireplace. Use a wet cloth to rinse. Dry with newspaper. Repeat these cleaning procedures until the glass is clean. Note: using good quality, sufficiently dry wood reduces carbon deposits on the glass.

2.7.2

Cleaning the fireplace

Removing ash

In order to prevent obstruction of the combustion air inlet grille, it is necessary to regularly empty the ash pit located under the cast grate. Collect the ash in a specially designed recipient (inflammable and fitted with a cover) - the presence of residual embers can cause a fire. For safety reasons, it is preferable to store the ashes outside. Use a soft, dry cloth to clean the metal parts of the fireplace. **Tip: Your ashes can be used as compost for your garden.**

Cleaning the bricks

Clean with a brush then apply linseed oil.

Cleaning the steel grate

Rub with household oil to make it shine.

Use an abrasive pad to remove rust.



2.7.3

Maintenance and Chimney Sweeping

Maintenance

The appliances must be checked at least once a year and repaired if necessary by a qualified professional.

The chimney connectors must always be maintained in good working order, their maintenance must be carried out at least once a year.

The fresh air ducts must always be maintained in good working order.

Clean the outside grille allowing fresh air intake (leaves, dust...) at the start of the heating season and check it periodically throughout the period of use.

Twice a year, vacuum any dust and soot which have collected in the slides on both sides of the door.

Lubricate the bearings of the door on each side with heat-resistant oil. To do so, completely lower the door and access the bearings via the inspection grille.



Clean the dust filters and grilles of the hood twice a year.



Clean the inside of the installation using a vacuum cleaner or brush in order to eliminate any dust deposits causing carbonization of dust (dirt around the hot air outlets and on the ceiling) at the start of the heating season and once during the heating season.

Check the condition of the door gaskets. Replace them if necessary.

N.B.: replacing gaskets requires the door to be dismantled. This work must be carried out by a professional.

Spare parts

If you wish to replace parts, broken glass or worn gaskets, contact your fitter, providing the references for your fireplace.

Chimney sweeping

3 Basic information about firewood

Totem fireplaces are high-performance appliances. Using good fuel is essential for optimal functioning of your fireplace. Wood is a renewable form of energy when it comes from sustainably managed forests. In France, forests represent 30% of the country's area. French forests have been expanding for several centuries. (*Fibra*) Here is some basic information about firewood.

3.1 General points

What is a stere of wood? A stere of wood corresponds to 1m³ of wooden logs measuring 1 m stacked parallel. However, since 1978, the legal sales unit is no longer the stere but the

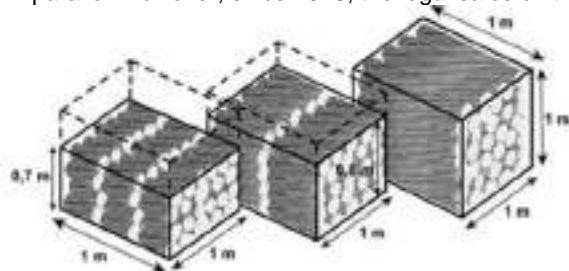

33 cm 50 cm 1 m

m³. A stere is not always equivalent to one 1 m³, the volume of the stere varies with the length of the logs. With smaller logs, the volume in m³ will decrease but you still have the same amount of wood. The spaces are filled better.

Below, 3 stere of wood in logs measuring 33, 50 and 100cm.

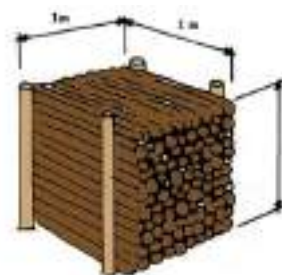

Which type of wood should I choose?

Birch: Birch burns quickly without its flames becoming too hot and leaves very little ash. It produces attractive, slightly bluish flames. It is a wood liked by bakers. It produces good embers and is used for lighting the fire.

Beech: Beech is excellent firewood: it dries quickly and offers good heating power. For drying, it must be placed under a shelter as soon as it has been resawn so that it does not rot. It is a wood which burns quickly, so it is easy to light. It emits pleasant odours when burning. It is considered the idea firewood. It produces attractive flames and good embers.

Oak: It burns very slowly. It has to be left for 1 year in the rain in order to remove all traces of tannin before being stored under shelter to dry. Oak produces the best embers. It burns slowly and produces a lot of heat.

Hornbeam: Hornbeam burns slowly which results in a good amount of heat production. Not much smoke is produced when burning. Hornbeam produces excellent embers which distribute heat over time. The flames that it produces are attractive and uniform.

Ash: Described as producing the most attractive flames, it is a wood which burns for a long time without projecting sparks and produces a large amount of heat. It is difficult to cut.

Chestnut: Chestnut is a strong wood. It used to be used for manufacturing barrels. It is mediocre firewood because it explodes and produces a lot of sparks when burning. When the fireplace door is lowered, it can be used without risk; when the door is raised we recommend that you use a fire screen.

Coniferous trees: Coniferous trees should not be used. This type of wood releases large amounts of heat but burns very quickly. When it burns it causes the projection of embers and the resins contained in the wood clog up the fireplaces and flues very quickly. These very large deposits of soot encourage fires to start in the flues.

Important :

- Oak and chestnut contain tannins which affect burning. They must be stored for 6 – 9 months in a non-sheltered area to remove the tannins before being stored in a sheltered area for a period of 2 years.
- Avoid burning too much bark as it creates 10% more ash.
- Also avoid using wood with knots in it as this reduces the appliance's performance
- Wood which is too dry is not good for burning. Indeed, the wood heats too quickly, does not burn for long enough and significantly increases the temperature of the smoke.
- Do not use wood gathered on beaches as it releases hydrogen chloride when burned.

There are 3 families of wood:

- hard hardwood (oak, beech, ash, chestnut, hornbeam, walnut...)
- soft hardwood (poplar, willow, alder, birch...)
- coniferous trees (pine, spruce, fir, larch, Douglas fir...)

We recommend that you use firewood from the hard hardwood family. It has better heating power for an equal volume. I.e., it has greater heating power for the same volume of wood burned. Here is a table presenting the heating power, with equal humidity and volume, of the different species of wood. The heating power is presented on the basis of beech wood (set arbitrarily at 100).

Species	Heating power
Recommended wood	
Hornbeam	110
Beech	100
Ash	97
False acacia	97
Oak	96
Elm	96

	Hard
	Soft
	Coniferous

Species	Heating power
Wood to avoid	
Birch	93
Chestnut	89
Maple	84
Lime	76
Alder	71
Poplar	60

Species	eating power
Wood which must not be used	
Spruce	68
Fir	64
Larch	84
Pine	78

3.2 Drying of wood and its moisture content

For wood, we generally speak of the moisture content, represented by H%, known as moisture content on dry basis (in relation to oven dry wood).

$$\text{Moisture content of wood: } H \% = \frac{\text{Mass of pure water}}{\text{Dry wood}} \times 100$$

Moisture content varies from 50 to 120% (or more) for saturated wood (green wood) and from 10 to 20% for air-dried wood. It is this value which is measured using our hygrometers. It is important to note that wood which contains too much moisture does not produce heat and that the more moisture the wood contains the less warmth it will provide. Indeed, the heat output produced by wood during burning is not used to warm you, it is used to evaporate the water that it contains. Furthermore, humid wood increases carbon monoxide emissions by a factor of 2 to 4 compared with dry wood and encourages clogging of your appliance, in this way decreasing its efficiency.



These figures correspond to the mean for hardwoods.

Furthermore, humid wood increases carbon monoxide emissions by a factor of 2 to 4 compared with dry wood and encourages clogging of your appliance, in this way decreasing its efficiency. This is why wood must be dried for at least 15 – 18 months and stored in a sheltered, ventilated place, away from water and out of direct sunlight. Wood must be resawn into logs, which encourages drying. The duration may vary but in the end, you must obtain wood with moisture content always lower than 25%. This content can be checked using our hygrometers which can be purchased from our distributors.



3.3 Types of fuel which are forbidden

- Plastic
- Liquids, solvents
- Household waste
- Hazardous or noxious waste
- Electronic components
- Lignite
- Coal, petrol, alcohol...



Totem fireplaces are designed for domestic use. They should under no circumstances be used to incinerate waste of any kind.

It is forbidden to use treated wood which may produce toxic fumes and clog up the installation.

For your safety, you should also avoid intense fires. **Recycled wood (pallets, joinery wood, planks...) must not therefore be used** as it results in overheating which could damage the appliance, the chimney connector and the chimney flue.

4 Warranty

4.1 Statutory warranty

The statutory warranty, complete and compulsory, stems from application of articles 1641 et. seq. of the Civil Code. If the buyer proves that there is a latent defect, the manufacturer must legally make good any foreseeable consequences.

4.2 Contract guarantee

The aim of the contract guarantee, which in no way excludes the statutory warranty, is to guarantee the buyer against any manufacturing faults or faulty material other than latent defects. The guarantee is valid for 5 years from the purchase date indicated by the seller. It includes, during this period, free exchange of faulty parts (parts). The appliance must be installed in such a way as to allow fast and easy disassembly and reassembly (inspection panel compulsory).

4.3 The following are not covered by the warranty

- damage caused by something external to the appliance (e.g. broken glass due to mechanical shock),
- damage resulting from forms of energy, use or installations which do not comply with the manufacturer's instructions and with legal and regulatory requirements
- damage entailing the liability of a third party or resulting from a deliberate act or willful misconduct
- wearing parts (brickwork, vitro-ceramics, vermiculite reflectors and combustion grilles).