



**HOUTKACHEL / POELE A BOIS
WOOD STOVE / HOLZOFEN**

250CB

250CBS



**INSTALLATIEVOORSCHRIFTEN EN GEBRUIKSAANWIJZING
INSTALLATION ET MODE D'EMPLOI
INSTALLATION INSTRUCTIONS AND OPERATING MANUAL
EINBAUANLEITUNG UND GEBRAUCHSANWEISUNG**

Table of contents

	<u>pag</u>
Foreword	20
1. Introduction.....	20
2. Safety.....	20
3. Installation guideline.....	21
3.1. Preliminary measures.....	21
3.1.1. The chimney.....	21
3.1.2. Ventilation.....	22
3.1.3. Floor, walls.....	22
3.2. Preparing the stove.....	23
3.2.1. Assembling and installing the legs.....	23
3.2.2. The smoke outlet.....	23
3.2.3. Assembling the “cold handle”	24
3.3. Finishing.....	24
3.4. Packaging materials.....	24
4. Instructions for use	25
4.1. Fuel.....	25
4.2. Lighting a fire.....	25
4.3. Burning wood.....	25
4.4. Low heating (for devices suitable for continuous use).....	26
4.5. Ash removal.....	26
4.6. Extinguishing the fire.....	26
4.7. Weather conditions.....	26
5. Maintenance.....	27
Annex 1 : Technical data sheet	36
Annex 2 : Dimensions.....	37

Inhalt

	<u>pag</u>
Vorwort.....	28
1. Einleitung.....	28
2. Sicherheit.....	28
3. Montagevorschrift.....	29
3.1. Vorher.....	29
3.1.1. Der Schornstein.....	29
3.1.2. Lüftung des Raumes	30
3.1.3. Fussboden, Wände	30
3.2. Vorbereitende Arbeiten.....	31
3.2.1. Montage der Füße.....	31
3.2.2. Rauchgasausgang.....	31
3.2.2. Montage des “kalten Handgriffs”	32
3.3. Abfertigung.....	32
3.4. Verpackungsmaterialien.....	32
4. Gebrauchsanleitung.....	33
4.1. Brennstoff.....	33
4.2. Anzünden.....	33
4.3. Heizen mit Holz	33
4.4. Geringes Heizen.....	34
4.5. Entaschen.....	34
4.6. Auslöschen.....	35
4.7. Wetterlage.....	35
5. Wartung.....	35
Anlage 1 : Technischen Daten	36
Anlage 2 : Abmessungen.....	37

Foreword

The Installation Manual and Operators Instructions must accompany this appliance. As well as instructions for installation and information about use, you will also find advice concerning safety and maintenance.

Please read this booklet carefully before installation and before firing the unit. Save this booklet and pass to any subsequent user who can also profit by it.

1. Introduction

Your DOVRE purchase has made you the owner of a high quality product that symbolizes a new generation of energy-saving and ecologically safe heaters, producing convection heat as well as radiant heat with optimum efficiency. Through the application of a revolutionary combustion concept DOVRE heaters achieve astonishing results in full compliance with strict environmental and safety norms. Also, you will be enjoying the lovely sight of the fire blazing in the stove.

Our heaters are produced in accordance with ISO 9002, using state-of-the-art production means.

In the unlikely event of a malfunction, you can always rely on DOVRE's after-sales service.

This heater is designed to be installed in a living room and to be hermetically connected to a flue (chimney).

If the stove is professionally installed, connected to a well-functioning chimney and sufficiently ventilated, you can take the long-term and trouble-free functioning of your heater for granted.

Please consult an expert when installing and connecting the heater.

2. Safety

The heater is designed to heat a room, which means that all surfaces, including the front glass, can get very hot (> 100 °C).

Please do not place any curtains, clothes, laundry, furniture or other combustible materials on or near the heater.

It is advised to make a fire in the stove with the highest possible intensity right after it is installed, so as to cure the heat-resistant paint finish. This may involve some odour production, which will however disappear after a while.

It is necessary to maintain and regularly clean the stove and the chimney for the stove to function safely and for a long period of time. Please follow the cleaning instructions in the chapter concerned.

In case of a chimney fire, immediately close all air intake vents of the appliance and alert the fireman.

Broken glass should be replaced before using the heater again.

The stove is specifically designed for burning certain kinds of fuels. In the technical specifications under cover you can find detailed information concerning this topic. It is absolutely prohibited to burn fuels other than these, as this may damage your heater. Moreover, it is ecologically harmful.

3. Installation guideline

3.1. Preparatory measures

The stove should be hermetically connected to a well-functioning chimney, sufficiently enclosed to keep combustible materials (floor and walls) at a distance, and should be installed in a room with sufficient ventilation.

Please inform about national or local norms and regulations concerning this subject. Your distributor will give you the necessary advice.

You can also consult the fire department and/or an insurance company about specific demands or regulations.

Please read the technical specifications under cover in this manual before installing the stove.

3.1.1. *The chimney*

The chimney (the flue) has a double function:

- It draws air, that is necessary for good combustion, into the stove.
- It functions as an exhaust pipe for combustion gases via thermal or natural draught. Thermal draught is caused by the difference in heat between the air in and outside the flue. The heated air in the flue is lighter than the colder air outside the flue and consequently rises up, along with the combustion gases. Natural draught is caused by environmental phenomena, such as wind.

It is prohibited to connect several heaters to one chimney (for instance the central heating boiler), unless local or national regulations allow this.

Please check which chimney is to be used for the stove you purchased and whether your chimney is appropriate for this specific usage. You should consider an expert's opinion on this matter.

The chimney should meet the following conditions:

- The flue should be made of fireproof material. Ceramic or stainless steel is recommended.
- The chimney should be airtight and thoroughly cleaned and should guarantee a sufficient draught (a draught or negative pressure of 15 to 20 Pa is ideal under normal circumstances).
- It should run as vertically as possible. Changes in direction or horizontal segments will disrupt the smoke flow and may cause soot to cumulate inside the flue (and clog the flue!).
- The chimney's inside dimensions must not be too large in order to prevent the smoke from cooling off too much. For recommended chimney dimensions, see the technical specification under cover. Larger dimensions can be used if the flue is well insulated.
- The flue's diameter should be the same throughout its whole length. Wider, or especially narrower segments will disrupt the smoke flow and are best avoided. The same is true for a cover plate or exhaust hood on top of the chimney. The exhaust hood must not narrow the chimney's outlet and should be designed in a

way that wind will not hinder, but promote the smoke flow.

- Especially if the flue runs through unheated rooms or outside the house, further insulation is necessary. Metal chimneys, or parts of the chimney outside heated rooms should always have double-walled, insulated flues. The part of the chimney outside the roof should always be insulated.
- The chimney should be high enough (at least four metres) and should end in a zone that is clear of nearby buildings, trees or other obstacles. The rule of thumb here is: 60 cm above the ridge of the roof. If the distance between the ridge and the chimney measures more than three metres, see the dimensions stipulated in the illustration below. Depending on the presence of nearby buildings or trees, the chimney should be higher.

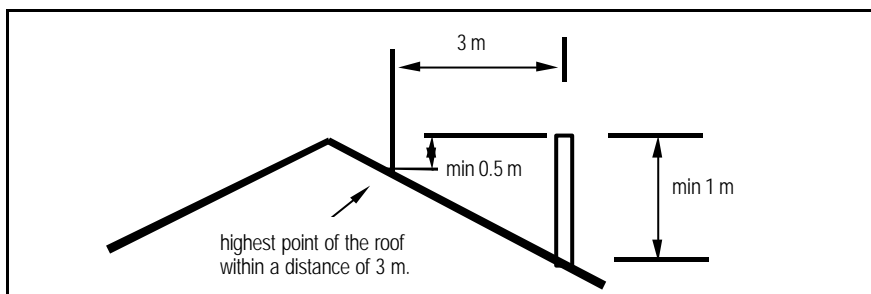

3.1.2. Ventilation

The burning of wood, charcoal or gas involves oxygen consumption. It is of the utmost importance that the room in which the stove is installed should be sufficiently ventilated.

Insufficient ventilation may disrupt the combustion process and cause the smoke flow through the chimney to be interrupted, which may lead to smoke emissions into the room.

If necessary, you can install a ventilation grille to provide a constant flow of fresh air in the room. This precaution is particularly necessary in well-insulated rooms with mechanical ventilation.

Ensure not to use other air-consuming appliances, such as heaters, cooking hoods, bathroom ventilators, in the same room or in the house while the stove is burning; or make sure to have an extra ventilation grille installed for these appliances.

3.1.3. Floor, walls

A safe distance should be kept between the stove and combustible materials such as wooden walls and furniture. If you purchased a freestanding stove, this distance should be at least forty centimetres.

The appliance shall be installed on floors with an adequate load-bearing capacity.

Combustible floors require sufficient protection against radiant heat by means of a fireproof protective plate. Rugs and carpets must be kept at a distance of at least eighty centimetres from the fire.

3.2. Preparing the stove

Please inspect the stove for damage caused during transport immediately after delivery and notify your distributor in case there are any defects. Do not put the stove into operation in the meantime.

In order to avoid damaging the stove during installation and to make handling of the stove easier, it is recommended to remove previously all loose parts (fire-resistant bricks, grille, ashtray, ...) from the stove. Note the location of those parts while removing them, so that you have no difficulties in re-assembling the parts later on.

The stove will be supplied with the following parts:

- A set of legs
- A connection collar with fastening brackets
- A "cold hand" to remove the ashtray
- A "cold handle" to open the door
- A small shovel to remove ashes

3.2.1. Assembling and installing the legs (see sketch)

Assemble both parts of the legs at the requested length using the M6 bolts and rings. Tilt the stove backwards and mount the legs on the pre-installed M8 bolts on the bottom plate of the stove.



3.2.2. The smoke outlet

The stove can be connected to the chimney at the rear or at the top.

Depending on the position chosen, one opening can be covered with the blanking plate supplied, the other one can be equipped with the connection collar supplied. Use the fixings supplied and be sure to tightly seal the connection collar and the blanking plate to the stove by means of the kit or paste supplied.

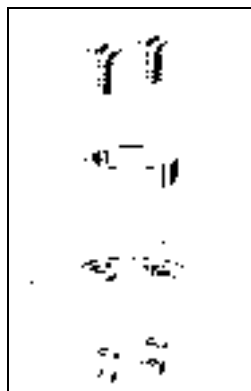
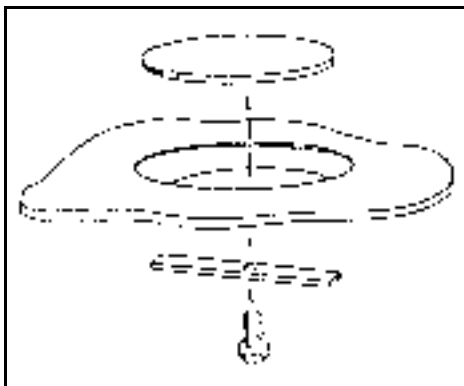

3.2.3. Assembling the “cold handle”

Assemble the different parts of the handle, i.e. a screw M8x50, a wooden handle, a hook and a nut, as indicated on the sketch.

For some appliances, this handle can be hooked on a handle holder which can be mounted on the base plate of the stove, near the left front leg (see sketch).

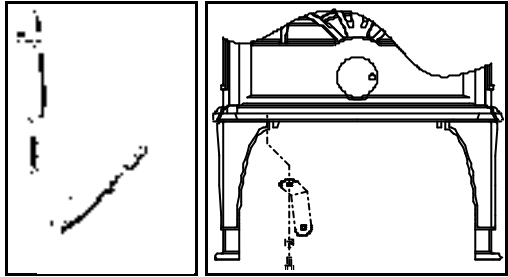

3.3. Finishing

When the stove is placed in the final position and hermetically connected to the chimney, you can replace all of the loose parts.

Your stove is now ready for use.

Attention: never light a fire with the inner plates or refractory stones removed.

3.4. Packaging materials

Packaging materials should be disposed of in a responsible way and in accordance with governmental regulations.

4. Instructions for use

4.1. Fuel

The only suitable fuels for this stove are wood and for 250CB also brown coal briquettes. No other fuels are allowed to be burnt, as they can inflict serious damage to your stove.

Do not burn any treated wood either, such as scrap wood, dyed wood, impregnated or preserved wood, plywood or chipboard. The fumes of these, as of synthetic materials, old papers and household waste, are highly polluting for both your stove and your chimney, and for the environment. They also could cause chimney fires.

Wood

Hard woods, such as oak, birch- and fruit-trees, are the ideal fuels for your stove.

The wood must have dried for at least two years in a covered and well-ventilated place. Split logs will dry faster. Dry wood should contain no more than twenty per cent moisture.

Wet logs are unsuitable for burning, as they do not produce enough heat and all of the energy is lost in the process of evaporation. Moreover, the burning of wet wood causes badly smelling gases to be released and a thick layer of tar will deposit on the stove panels and in the chimney.

Brown coal briquettes (only for 250CB)

Brown coal briquettes burn in more or less the same way as wood does. You should only burn briquettes on a bed of charcoal in your stove.

4.2. Lighting a fire

In order to create sufficient draught and to prevent smoke from being emitted into the room, the chimney should be warm enough before lighting a fire. A cold chimney can be heated up by lighting a ball of paper above the fire plate.

To kindle the fire in the stove you can use paper and/or firelighters and small pieces of wood.

Slightly open the door and pull the air slides wide open. See the sketch on how to use the air slides.

It is important that the kindled fire should burn intensely. You can then throw larger pieces of wood onto the fire, and close the doors. When the fire has eventually stabilized and is glowing enough, you can put the logs or the brown coal briquettes on the fire.

4.3. Burning wood

The best way to control the fire is to completely close the lower air slide, which you use to get the fire started, and to regulate the air supply with the upper air slide only. In case the air supply through the upper air slide seems insufficient, or if you would like to fan the fire, you can partially open the lower air slide for a while.

Always keep the stove doors tightly closed. Never let the doors open when the fire is burning.

Add extra fuel when necessary. Never add too much fuel. It is best to fill the stove

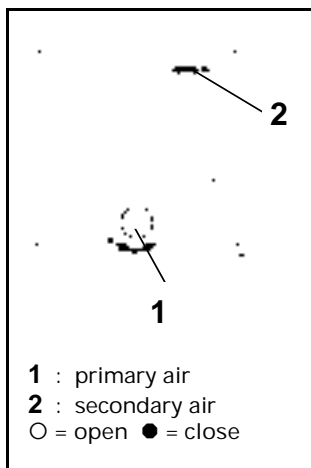

for one third and to top it up on a regular basis.

Always open the filling door slowly and for a short space of time. Before filling up, the charcoal bed should be carefully spread open. Check whether the coals are glowing enough just behind the log retainer, so that the added fuel will immediately catch fire. If necessary you can open the lower air slide for a while.

Open stacking will make the logs burn very intensely, as the oxygen can easily reach every part of the fire. This method of stacking is applied when burning wood for a short while. Compact stacking will make the fire burn slower, as the air can only reach the outer parts of the fire. This stacking method is best used when burning for a longer while.

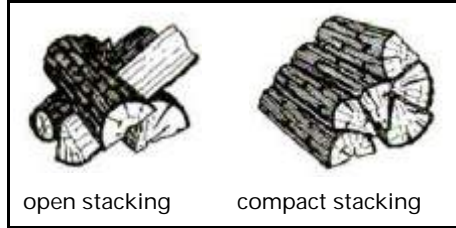

Low intensity fires cause tar and creosote to deposit in the chimney after a long period of time. Tar and creosote are highly combustible substances. Thicker layers of these substances might catch fire when the temperature in the chimney increases suddenly and steeply. Therefore it is necessary for the fire to regularly burn very intensely, so that thin layers of tar and creosote immediately disappear.

Low intensity fires also cause tar to deposit on the stove panes and doors. When it is not too cold outside it is better to let the stove burn intensely for just a few hours a day.

4.5 Low heating (for devices suitable for continuous use)

To use the device as a 'continuous fire', you can select the primary and secondary air scoops in such a way you get the right burning speed. Always make sure there's enough glow on the heating bottom.

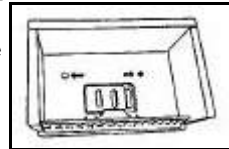

4.6. Ash removal (only for 250CB)

The bottom part of the fire compartment is equipped with an ash removal grille. To remove the ashes, open or remove the grille, and sweep the ashes into the ashtray with the small shovel. Use the "cold handle" to remove the ashtray out of the stove (see illustration).



Relatively speaking, burning wood produces little ash and it will not be necessary to remove it each time daily. Moreover, wood burns better on a bed of ash.

4.7. Extinguishing the fire

Stop fuelling the fire and let it burn out.

Damping a fire by closing the air slides involves the release of noxious gases. You should let the fire burn out and keep an eye on it as long as it is still glowing.

4.8. Weather conditions

Attention!

5. Maintenance

It takes only little effort to keep your stove in good condition.

Regularly check whether the sealing cord still closes the doors tightly enough.

The painted or enamelled cast iron mantle can be cleaned with a moist, soft cloth, when it is almost cold.

Minor paint damage can be touched up with a can of spray paint. Your dealer can supply you with the correct spray product. For enamel damage, small repair kits of appropriate colour are available with your dealer.

During the first use after repainting your unit might give off some slight odour. However, this will disappear quickly.

The glass can be cleaned with a number of glass cleaning products available on the market. Your installer can also supply you with appropriate products. However, never use abrasive or corrosive cleaning products.

A tight upper air slide can be adjusted with the two screws just above the air intake holes on the front plate (see sketch).

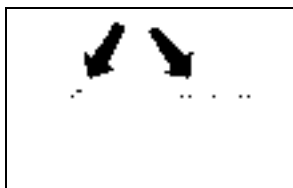

At the end of the heating season, seal off the chimney with a ball of paper. You can then thoroughly clean the stove on the inside.

If necessary, replace the sealing ropes and use fire cement to fill up possible leaks. Remove the fire plate for better and more thorough cleaning.

You should have your chimney swept by an expert before the heating season begins. It is useful to check the chimney for soot during the heating season as well. Checking and maintaining the chimney is a statutory requirement.

When all of the above advice is heeded, you will be able to fully enjoy your stove.

- Annex 1 : technical data sheet**
Anlage 1 : technischen Daten
Bijlage 1 : technische gegevens
Annexe 1 : données techniques

Model / Modèle / Modell	250CB/250CBS
Nominaal vermogen Puissance nominale Nominal heat output Nominalleistung	6 kW
Aanbevolen brandstoffen Combustibles conseillés Advised combustibles Empfohlene Brennstoffe	Hout (250CB: + bruinkoolbriketten) Bois (250CB: +briquettes de lignite Wood (250CB: + brown coal Holz (250CB: + Braunkohlebriketts
Maximale lengte houtblokken Longueur maximale des bûches Maximal length of logs Maximal Länge der Holzblocken	33 cm
Schoorsteenaansluiting (diameter) Raccordement cheminée (diamètre) Flue connection (diameter) Schornsteinanschluss (Diameter)	125 mm
Massadebiet van rookgassen Débit des fumées Flue gas mass flow Abgasmassenstrom	6.3 g/s (hout, bois, wood, Holz) 6.6 g/s (bruinkoolbriketten, briquetes de lignite, brown coal, Braunkohlebrik- kets)
Rookgastemperatuur Température des fumées Flue gas temperature Abgasstutztemperatur	253°C (hout, bois, wood, Holz) 252 °C (bruinkoolbriketten, briquetes de lignite, brown coal, Braunkohlebrik- kets)
Minimum trek Dépression minimal Minimum draught Mindesförderdruck	0.11 mbar
Gewicht / Poids / Weight	80 kg

- Annex 2 : dimensions**
Anlage 2 : Abmessungen
Bijlage 2 : afmetingen
Annexe 2 : dimensions

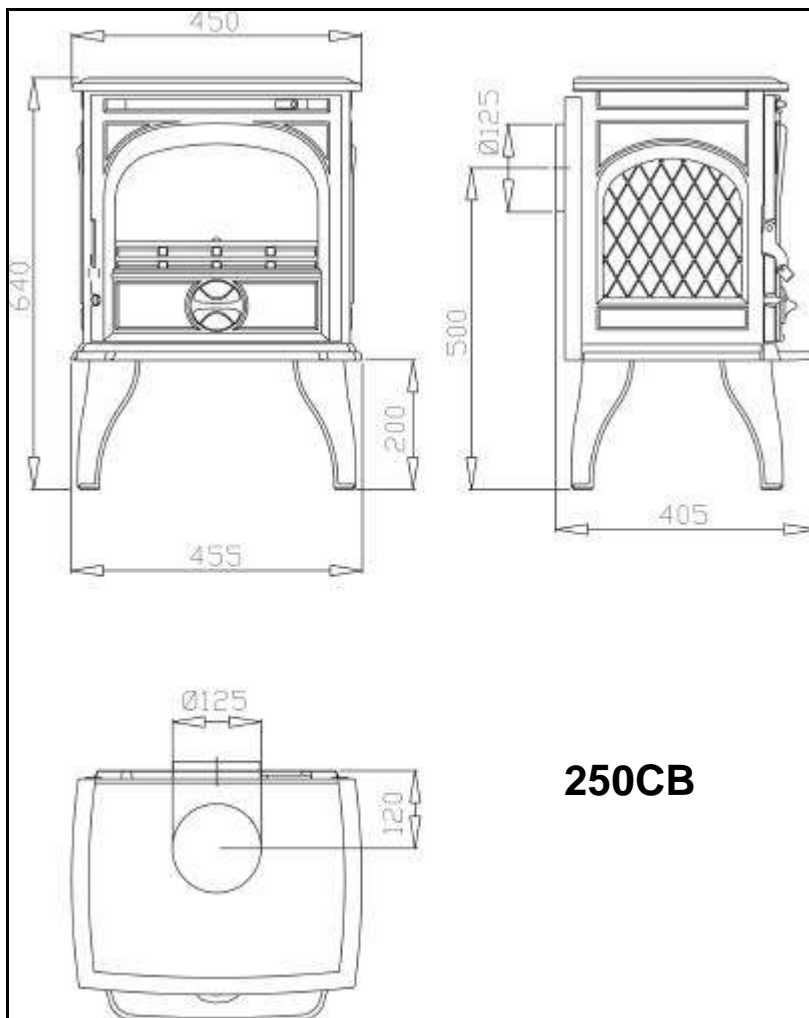

250CB

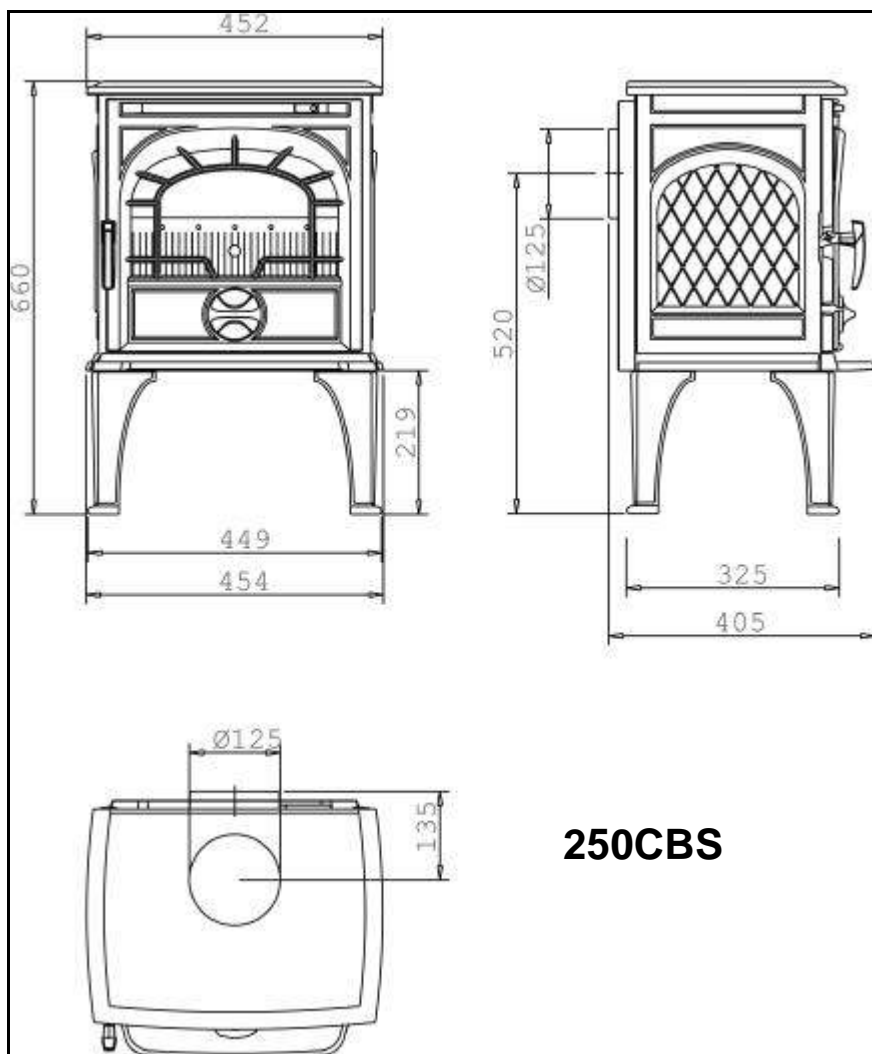

CE-conformiteitsverklaring
Declaration de conformité CE
EC Declaration of conformity
Konformitätserklärung CE



Notified body: 1641

Wij,
Nous,
We,
Wir,

Dovre nv, Nijverheidsstraat 18, B2381 Weelde,

verklaren bij deze dat de houtkachel 250CB/250CBS conform is volgens de EN 13240.

déclarons que le poêle 250CB/250CBS est conforme au norme EN 13240.

declare that the wood stove 250CB/250CBSest in conformity with the EN 13240.

Erklären daß das Produkt 250CB/250CBS entspricht EN 13240.

Weelde, 29.08.2005

T. Gehem

In het kader van een continue productverbetering, kunnen specificaties van het geleverde toestel afwijken van de beschrijving in deze brochure, zonder voorafgaande kennisgeving.

Dans le cadre d'une amélioration constante des produits, les spécifications du produit livré peuvent différer du contenu de ce document, sans avis préalable.

Due to continuous product improvement, specifications of the delivered product may differ from the content of this booklet, without further notice.

Im Rahmen kontinuierlicher Produktverbesserung, können Spezifikationen des geliefertes Produktes von den Beschreibungen in dieser Broschüre abweichen.

DOVRE N.V.
Nijverheidsstraat 18
B-2381 Weelde

Tel : +32 (0) 14 65 91 91
Fax : +32 (0) 14 65 90 09
E-mail : info@dovre.be



United Kingdom and Eire distributors for Dove:

STOVAX

Stovax Limited, Falcon Road, Sowton Industrial Estate, Exeter, Devon, England, EX2 7LF.

Telephone: (01392) 474011 Fax: (01392) 219932

E-mail: dove@stovax.com Internet: www.dove.co.uk

E & O E